



Multi-Format Processor

EXT-MFP

User Manual



Release A4

Important Safety Instructions

1. Read these instructions.
2. Keep these instructions.
3. Heed all warnings.
4. Follow all instructions.
5. Do not use this product near water.
6. Clean only with a dry cloth.
7. Do not block any ventilation openings. Install in accordance with the manufacturer's instructions.
8. Do not install or place this product near any heat sources such as radiators, heat registers, stoves, or other apparatus (including amplifiers) that produce heat.
9. Do not defeat the safety purpose of the polarized or grounding-type plug. A polarized plug has two blades with one wider than the other. A grounding type plug has two blades and a third grounding prong. The wide blade or the third prong are provided for your safety. If the provided plug does not fit into your outlet, consult an electrician for replacement of the obsolete outlet.
10. Protect the power cord from being walked on or pinched particularly at plugs, convenience receptacles, and the point where they exit from the apparatus.
11. Only use attachments/accessories specified by the manufacturer.
12. To reduce the risk of electric shock and/or damage to this product, never handle or touch this unit or power cord if your hands are wet or damp. Do not expose this product to rain or moisture.
13. Unplug this apparatus during lightning storms or when unused for long periods of time.
14. Refer all servicing to qualified service personnel. Servicing is required when the apparatus has been damaged in any way, such as power-supply cord or plug is damaged, liquid has been spilled or objects have fallen into the apparatus, the apparatus has been exposed to rain or moisture, does not operate normally, or has been dropped.
15. Batteries that may be included with this product and/or accessories should never be exposed to open flame or excessive heat. Always dispose of used batteries according to the instructions.

Warranty Information

Gefen warrants the equipment it manufactures to be free from defects in material and workmanship.

If equipment fails because of such defects and Gefen is notified within two (2) years from the date of shipment, Gefen will, at its option, repair or replace the equipment, provided that the equipment has not been subjected to mechanical, electrical, or other abuse or modifications. Equipment that fails under conditions other than those covered will be repaired at the current price of parts and labor in effect at the time of repair. Such repairs are warranted for ninety (90) days from the day of reshipment to the Buyer.

This warranty is in lieu of all other warranties expressed or implied, including without limitation, any implied warranty or merchantability or fitness for any particular purpose, all of which are expressly disclaimed.

1. Proof of sale may be required in order to claim warranty.
2. Customers outside the US are responsible for shipping charges to and from Gefen.
3. Copper cables are limited to a 30 day warranty and cables must be in their original condition.

The information in this manual has been carefully checked and is believed to be accurate. However, Gefen assumes no responsibility for any inaccuracies that may be contained in this manual. In no event will Gefen be liable for direct, indirect, special, incidental, or consequential damages resulting from any defect or omission in this manual, even if advised of the possibility of such damages. The technical information contained herein regarding the features and specifications is subject to change without notice.

For the latest warranty coverage information, refer to the Warranty and Return Policy under the Support section of the Gefen Web site at www.gefen.com.

Technical Support

(818) 772-9100 (800) 545-6900
8:00 AM to 5:00 PM Monday - Friday, Pacific Time

Fax

(818) 772-9120

Email

support@gefen.com

Web

<http://www.gefen.com>

Mailing Address

Gefen, LLC
c/o Customer Service
20600 Nordhoff St.
Chatsworth, CA 91311

Product Registration

Register your product here: <http://www.gefen.com/kvm/Registry/Registration.jsp>

Operating Notes

- Audio from the selected 2-channel analog inputs will be automatically embedded into the HDMI output signal.
- By default, the current input and output resolution will be displayed whenever the Mult-Format Processor is disconnected from the source or display or if a change in the video output settings are made. This feature can be disabled through the Display Notify option. See [Menu System \(page 17\)](#) and the `#set_display_notify` command for more information.
- The Gefen Syner-G Software Suite is a free downloadable application from Gefen that provides automatic download and installation of firmware upgrades for this product.

Download the application here: <http://www.gefen.com/support/download.jsp>

Multi-Format Processor is a trademark of Gefen, LLC.

© 2015 Gefen, LLC. All Rights Reserved. All trademarks are the property of their respective owners.

Gefen, LLC reserves the right to make changes in the hardware, packaging, and any accompanying documentation without prior written notice.



This product uses UL or CE listed power supplies.

This product uses software that is subject to open source licenses, including one or more of the General Public License Version 2 and Version 2.1, Lesser General Public License Version 2.1 and Version 3, BSD, and BSD-style licenses. Distribution and use of this product is subject to the license terms and limitations of liability provided in those licenses. Specific license terms and Copyright Notifications are provided in the source code.

For three years from date of activation of this product, any party may request, and we will supply, for software covered by an applicable license (e.g. GPL or LGPL), a complete machine-readable copy of the corresponding open source code on a medium customarily used for software interchange. The following software and libraries are included with this product and subject to their respective open source licenses:

- lwIP
- jQuery

lwIP is licenced under the BSD licence:

Copyright (c) 2001-2004 Swedish Institute of Computer Science.
All rights reserved.

Redistribution and use in source and binary forms, with or without modification, are permitted provided that the following conditions are met:

1. Redistributions of source code must retain the above copyright notice, this list of conditions and the following disclaimer.
2. Redistributions in binary form must reproduce the above copyright notice, this list of conditions and the following disclaimer in the documentation and/or other materials provided with the distribution.
3. The name of the author may not be used to endorse or promote products derived from this software without specific prior written permission.

THIS SOFTWARE IS PROVIDED BY THE AUTHOR "AS IS" AND ANY EXPRESS OR IMPLIED WARRANTIES, INCLUDING, BUT NOT LIMITED TO, THE IMPLIED WARRANTIES OF MERCHANTABILITY AND FITNESS FOR A PARTICULAR PURPOSE ARE DISCLAIMED. IN NO EVENT SHALL THE AUTHOR BE LIABLE FOR ANY DIRECT, INDIRECT, INCIDENTAL, SPECIAL, EXEMPLARY, OR CONSEQUENTIAL DAMAGES (INCLUDING, BUT NOT LIMITED TO, PROCUREMENT OF SUBSTITUTE GOODS OR SERVICES; LOSS OF USE, DATA, OR PROFITS; OR BUSINESS INTERRUPTION) HOWEVER CAUSED AND ON ANY THEORY OF LIABILITY, WHETHER IN CONTRACT, STRICT LIABILITY, OR TORT (INCLUDING NEGLIGENCE OR OTHERWISE) ARISING IN ANY WAY OUT OF THE USE OF THIS SOFTWARE, EVEN IF ADVISED OF THE POSSIBILITY OF SUCH DAMAGE.

Features and Packing List

Features

- Independent and configurable audio and video routing
- Supports input and output resolutions up to 1080p Full HD & 1920 x 1200 (WUXGA)
- HDCP compliant
- HDMI, DisplayPort, DVI, VGA, and Composite Video inputs
- DisplayPort input is compatible with Mac and PC computers
- TOSLINK® optical digital, S/PDIF coaxial digital, and two analog L/R audio inputs
- Each audio source can be independently assigned to any video source
- Audio sources can be temporarily switched away from their assigned video sources
- On-screen display (OSD) menu and web server interface allow easy set-up & control
- IP control via Telnet, UDP, and web server interface
- RS-232 Serial interface for use with an automation control system
- Independent IR control of up to four units in proximity, using distinct command sets
- Password-protected user and administrative access
- Advanced EDID Management for rapid integration of sources and displays
- Assignable input naming
- System Configuration Upload/Download function
- Plug-and-Play installation with little to no set-up
- Locking power supply connector
- Rack-mountable using EXT-RACK-1U-GRY (available separately)
- Surface-mountable using the included L-brackets



Packing List

The Multi-Format Processor ships with the items listed below. If any of these items are not present in the box when you first open it, immediately contact your dealer or Gefen.

- 1 x Multi-Format Processor
- 1 x 6-pin Phoenix Plug
- 2 x L-shaped Brackets for surface mounting
- 4 x Mounting Screws for L-shaped brackets
- 2 x Mounting Screws
- 4 x Self-Adhesive Rubber Feet
- 1 x IR Remote Control
- 1 x 12V DC Power Supply
- 1 x Quick-Start Guide

1 Getting Started

Introduction.....	2
IR Remote Control	5
Installing the Batteries.....	7
Setting the IR Channel.....	8
Installation	9
Connection Instructions.....	9
Sample Wiring Diagram	10

2 Basic Operation

Front-Panel Controls	14
Powering the Multi-Format Processor	14
Selecting a Video Input	15
Selecting an Audio Input	15
Using the IR Remote Control	16
Menu System	17
Accessing the Menu System.....	17
Setting the Output Resolution	18
Displaying the Input / Output Resolution.....	20
Adjusting the Contrast.....	21
Adjusting the Brightness	23
Adjusting the Saturation	25
Adjusting the Hue.....	27
Adjusting the Color Range	29
Adjusting the Color Temperature	31
Adjusting the Color Balance.....	34
Adjusting the Sharpness	37
Using Auto Size.....	39
Adjusting the Phase	41
Adjusting the Vertical Position.....	44
Adjusting the Horizontal Position	47
Adjusting Underscan / Overscan.....	50
Adjusting the Aspect Ratio	53
HDCP	56
Sending an HPD Pulse	59
Enabling / Disabling Analog Audio Output	61
Setting the Analog Audio Mode.....	63
Audio Linking.....	65
Changing the IP Settings	68
Changing the System Settings.....	71
OSD Timeout	72
Display Notify	72
Lower Power	73
Set Feedback	73
Input Res. Info.....	73

Firmware Version	73
Multi-Format Processor IR Channel	74
Factory Reset	74
Control Methods	75
Contact Control	75
RS-232 Control	76
IP Control	76
Syner-G Discovery Tool	77
Using the Gefen Syner-G Discovery Tool	78
Web Interface	80
Using the Built-in Web Interface	80
Main	81
Status	83
Setup ► Output	84
Setup ► Picture	86
Setup ► Input	88
Setup ► Audio	90
Setup ► Names	94
Setup ► HPD Pulse	95
Setup ► HDCP	96
Manage EDID ► EDID Mode	97
Manage EDID ► EDID Copy	98
Manage EDID ► EDID Info	99
Manage EDID ► Edit Bank Names	100
Manage EDID ► Upload/Download	101
Network ► IP Settings	102
Network ► TCP/Telnet Settings	103
Network ► UDP Settings	104
Network ► Web Login Settings	105
Network ► Discovery Protocol Settings	106
System	108

3 Advanced Operation

RS-232 Interface	114
RS-232 Interface	114
RS-232 Settings	114
IP Configuration	115
Commands	116

4 Appendix

Default Settings	238
Rack Tray Installation	240
Specifications	241
Index	243

Multi-Format Processor

1

Getting Started

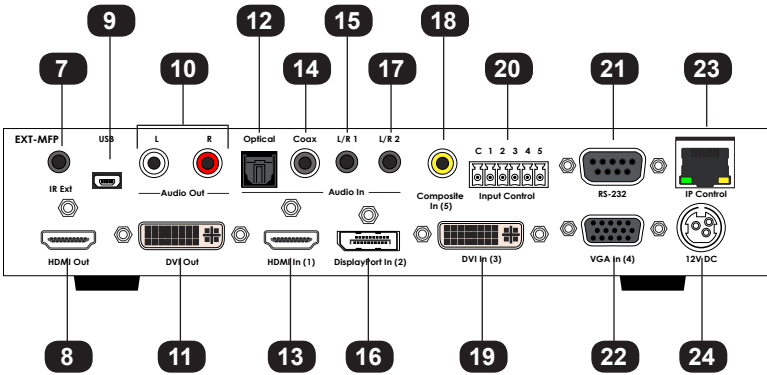
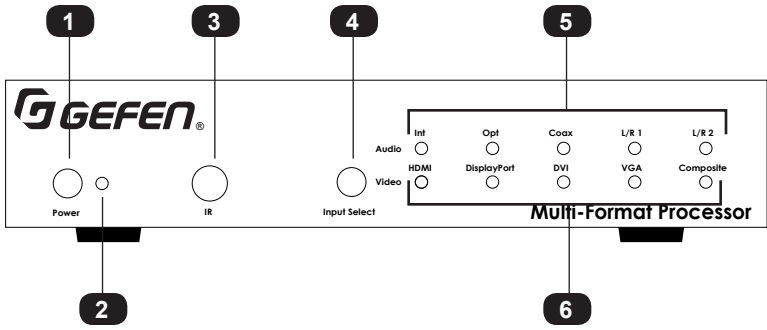

ID	Name	Description
1	Power	Press this button to power-on or power-off the Multi-Format Processor.
2	Power Indicator	This LED indicator will glow solid red when in standby mode and solid blue when the unit is powered on.
3	IR	Receives signals from the included IR remote control.
4	Input Select	Press and release this button to select the video input. Audio inputs are selectable and can be linked to video inputs using the built-in Web interface. See Setup ► Audio (page 90) for more information.
5	Audio Indicators	These LED indicator will glow solid green to indicate the currently selected audio input.
6	Video Indicators	These LED indicator will glow solid green to indicate the currently selected video input.
7	IR Ext	Connect an (optional Gefen EXT-RMT-EXTIRN) IR extender to this port.
8	HDMI Out	Connect an HDMI cable from this port to an HD display. The HDMI output includes internal HDMI audio or embedded audio from any of the audio inputs.
9	USB	This mini-USB port is for factory use only.
10	Audio Out	Connect a pair of RCA-type cables from the L and R ports to an audio amplifier.
11	DVI Out	Connect a DVI cable from this port to an HD display. This output can be used as an HDMI output using an appropriate adapter. When used as HDMI, audio is also supported through this output.
12	Optical	Connect an optical audio cable from this TOSLINK™ port to an audio amplifier.

ID	Name	Description
13	HDMI In (1)	Connect an HDMI cable from an HD source to this port. A DVI source can be connected using an adapter.
14	Coax	Connect an RCA-type cable from the digital output of the source to this port.
15	L/R 1	Connect a 3.5mm mini-stereo cable from the audio output of the source to this port. Use an adapter cable if the source has RCA-type jacks.
16	DisplayPort In (2)	Connect a DisplayPort cable from the source to this port.
17	L/R 2	Connect a 3.5mm mini-stereo cable from the audio output of the source to this port. Use an adapter cable if the source has RCA-type jacks.
18	Composite (5)	Connect an RCA-type cable from the Composite Video output of the source to this port.
19	DVI In (3)	Connect a DVI cable from the source to this port. An HDMI source (with audio) can be connected using an adapter.
20	Input Control	Video inputs (with associated audio) can be selected by connecting switches here. See page Contact Control (page 75) for details.
21	RS-232	Connect an RS-232 cable from this port to an RS-232 control device.
22	VGA In (4)	Connect the included VGA cable from a VGA source (e.g. computer) to this port. Component video can also be connected using an adaptor cable.
23	IP Control	Connect a CAT-5e cable (or better) from this port to the network.
24	12V DC	Connect the included 12V DC power supply to this power receptacle.

IR Remote Control

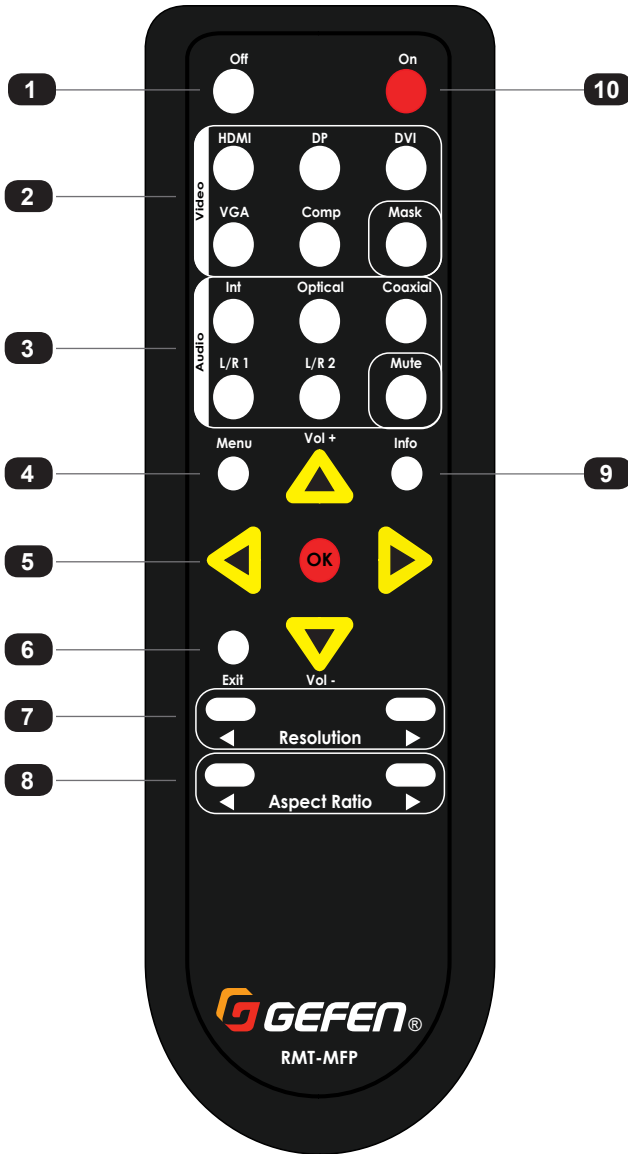

ID	Name	Description
1	Off	Press this button to place the Multi-Format Processor in Standby mode.
2	Video	Press one of these buttons to select the video input. This will also select a linked Audio input. "Mask" will turn off the Video output.
3	Audio	Press one of these buttons to change the audio input. The video source will not change. "Mute" will turn off the audio.
4	Menu	Press this button to display the On-Screen Menu.
5	Navigation Arrows / Analog Volume Control	Press these buttons to navigate the On-Screen Display. The ▲ or ▼ buttons also control analog audio volume when the On-Screen Display is inactive.
6	Exit	Press this button to "back up" in the On-Screen Menu, or to close the Menu entirely.
7	Resolution	These buttons cycle through the available Resolution options.
8	Aspect Ratio	These buttons cycle through the available Aspect Ratio options.
9	Info	Press this button to display current system status on the On-Screen Display.
10	On	Press this button to power-on the Multi-Format Processor.

Installing the Batteries



Warning!

Risk of explosion if battery is replaced by an incorrect type. Dispose of used batteries according to the instructions.

1. Remove the battery cover on the bottom of the IR remote control unit.
2. Make sure that the batteries are installed with the correct polarity, as shown in the illustration, below. Always use two 1.5V AAA-type batteries.
3. Replace the battery cover.



Setting the IR Channel



Information

In order for the IR remote control to function properly, both the IR remote control and the Multi-Format Processor must be set to the same IR channel.

1. Remove the battery cover on the bottom of the IR remote control unit.
2. Locate the DIP switches, below the battery compartment.
3. Use the table, below, to set the IR remote control to the desired IR channel.
4. Replace the battery cover.



IR channel	DIP switch setting
1	
2	
3	
4	

DIP switches

Connection Instructions

▶ Video Connections

1. Use an appropriate cable to connect each video source to the corresponding video input on the MFP. The HDMI, DisplayPort, and DVI inputs can include embedded audio. The DVI input only supports audio from an HDMI source with the proper cable and/or adapter). The **VGA** and **Composite** inputs require an external audio input.
2. Connect an HDMI cable from the **HDMI Out** and/or DVI Out port(s) to HD display(s). Both displays will show identical content, but may be used for a direct display and a projector, for example.

▶ Audio Connections

3. Use appropriate cables to connect each audio source to the proper audio input on the MFP. Audio inputs can be associated with a specific video input through system configuration, but they can also be switched independently.



Information

Only the embedded audio from the currently selected digital video source, or any independent audio source can be selected (e.g. You cannot display DP video with HDMI audio, etc.).

4. Connect the analog audio outputs to an audio amplifier and speakers, or you can use the speakers in the display, if available, over the existing HDMI connection.

▶ Control Options

5. Connect the IP Control port to the LAN with a network cable. The connected LAN should be available to the participants that will be controlling the presentations.
6. If desired, connect the RS-232 input to an external RS-232 controller or automation system.
7. If desired, connect dry-contact pushbuttons to the Input Control terminals
8. If desired, connect an IR Extender (Gefen part no. EXT-RMT-EXTIRN) to the IR Ext port to allow use of the included IR remote if the IR “eye” on the front of the MFP is not within range of the remote.

▶ Power

9. Connect the included power supply to the 12V DC power receptacle and connect the power cord to an available electrical outlet.

Sample Wiring Diagram

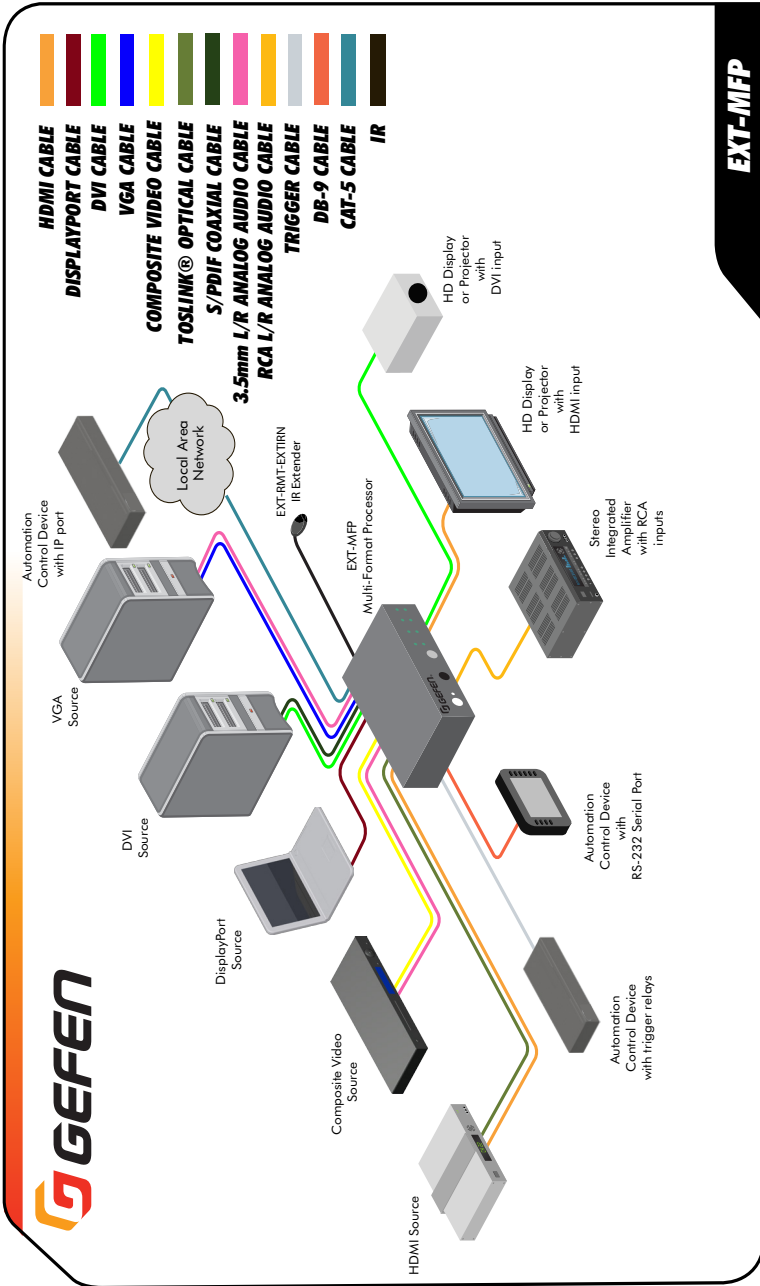

EXT-MFP

Multi-Format Processor

2

Basic Operation

Powering the Multi-Format Processor

1. Make sure the included 12V DC power supply is connected from the Multi-Format Processor to an available electrical outlet.
2. Press and release the **Power** button on the front panel.
3. The power indicator will glow solid blue.

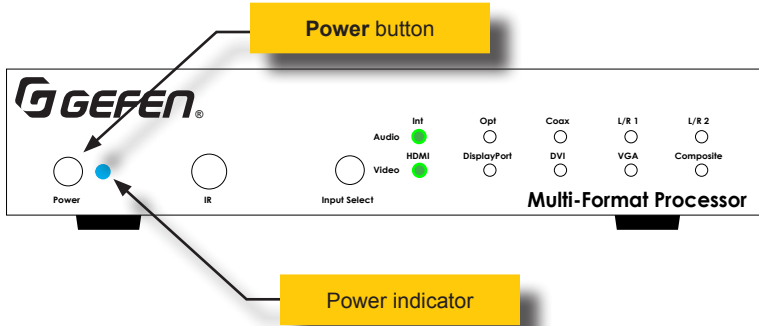

4. To power-off the Multi Format Processor, press and release the **Power** button.
5. The power indicator will turn **red**.



Information

The Multi-Format Processor can also be turned on and off with the IR Remote Control, the Web GUI, or by an external controller using either RS-232 or IP Telnet control.

Selecting a Video Input

The Multi-Format Processor allows you to switch between five simultaneous connections. By default, the HDMI port is active. The Multi-Format Processor will cycle through each of the following inputs, in order: HDMI, DisplayPort, DVI, VGA, and Composite.

1. Press and release the **Input Select** button to cycle through each of the available inputs.
2. The input indicator will glow solid green to denote the active input. For example, in the illustration below, the **DisplayPort** input indicator is illuminated.

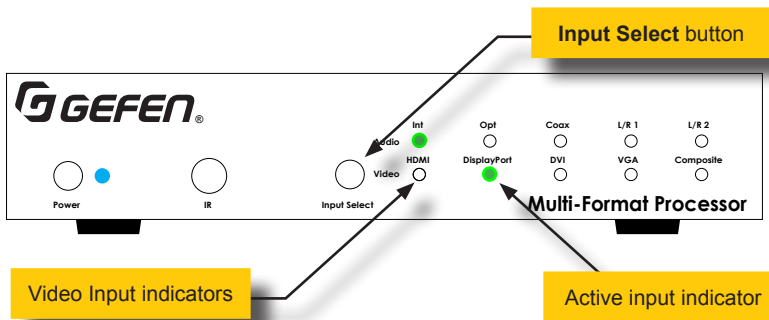

3. Press and release the **Input Select** button to advance to the next input (**DVI**). The input indicators will always be selected from left to right.
4. Continue with this process until the desired input is selected.
5. Once the **Composite** input is selected, pressing the **Input Select** button again will select the **HDMI** input.



Information

The Video Input Selection can also be changed with the IR Remote Control, the Web GUI, or by an external controller using either RS-232 or IP Telnet control, or via the Contact Closure Inputs on the back panel.

Selecting an Audio Input

Audio inputs must be selected and/or paired with video inputs using the built-in Web interface. See [Setup ► Audio \(page 90\)](#) for more information.

Using the IR Remote Control

You can use the included IR Remote Control to operate the Multi-Format Processor, by pointing the remote at the IR Window on the unit. If the Multi-Format Processor is concealed in a cabinet or otherwise out of range of the remote, you can plug in a Gefen IR Extender (Gefen part no. EXT-RMT-EXTIR) to the **IR Ext** port on the back panel, and place the sensor where it will be in range of the remote.

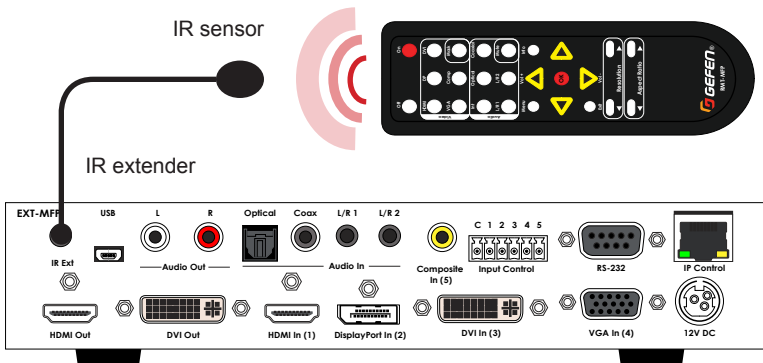
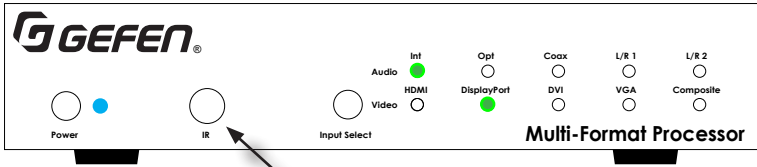

Accessing the Menu System

Input selection can be controlled using the front panel of the The Multi-Format Processor. However, the included IR remote control must be used to access the built-in menu system. The menu system is used to manage and control both audio and video features.

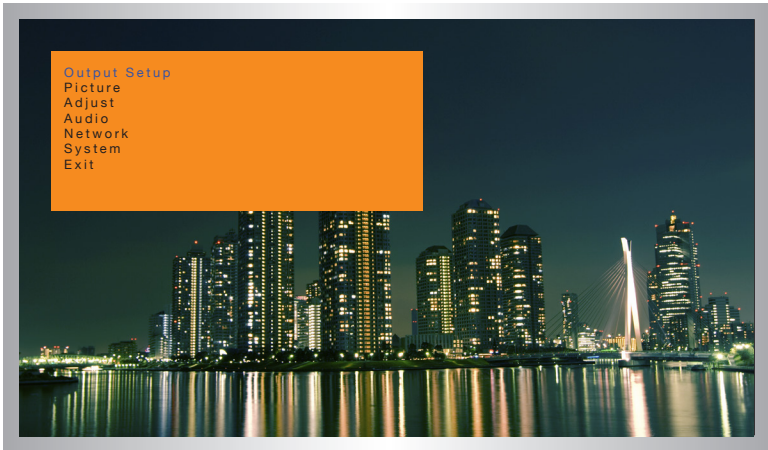

To access the menu system, press the **Menu** button on the included IR remote control. The default time-out value for the menu system is 5 seconds. This value can be changed under the [System \(page 108\)](#) section of the menu system.

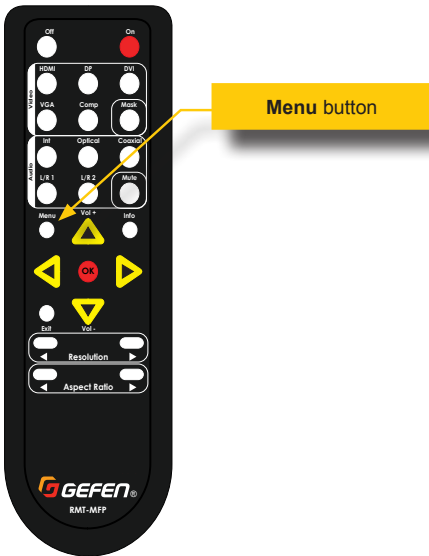

Setting the Output Resolution



Important

Before changing this setting, make sure that the connected display can support the selected output resolution.

1. Press the **Menu** button on the IR remote control. The **Output Setup** option will be highlighted in blue.

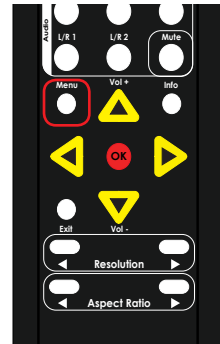
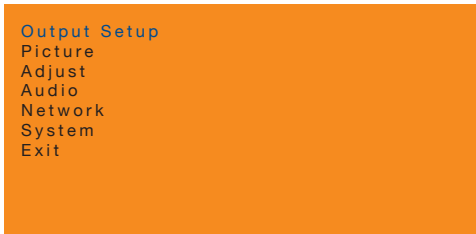

2. Press the **OK** button. The **Resolution** option will be highlighted in blue and will indicate the current output resolution.

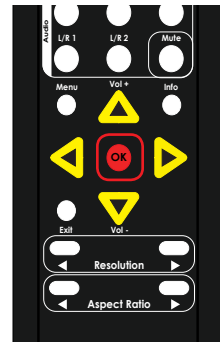
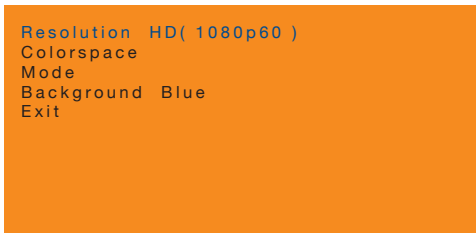

3. Press the **OK** button, again, to select the **Resolution** option.

- The current output resolution will be highlighted in red.

```
Resolution HD( 1080p60 )
Colorspace
Mode
Background Blue
Exit
```

- Press the ▲, ▼, ◀, or ▶ buttons to select the desired output resolution.

```
Resolution HD( 720p60 )
Colorspace
Mode
Background Blue
Exit
```

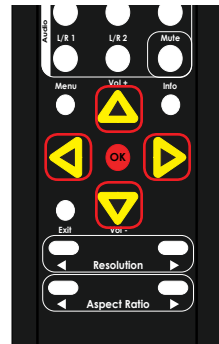

For a complete listing of available output resolutions, see the `#set_output_res` command.

- Press the **OK** button to accept the selected output resolution.
- The display will flash when the output resolution is changed.
- Once the resolution has changed, the following display notification will be displayed momentarily (the resolution information will vary depending on your selection).

```
IN : HDMI
    1280 x 720 / 60
OUT: 720p60
```

The timeout value for the display notification can be changed under the [Display Notify \(page 72\)](#) section of the menu system.

Note that the output resolution can also be changed by pressing the ◀ or ▶ **Resolution** buttons.

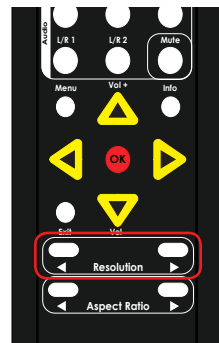

Displaying the Input / Output Resolution

1. Press the **Info** button on the IR remote control.

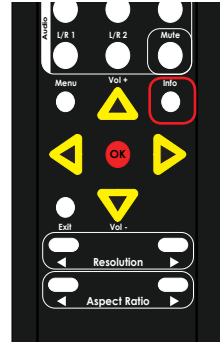

2. The **Display Notify** will be displayed .



3. The **Display Info** window will automatically disappear after the timeout period has expired. You can also press the **Info** button again to dismiss the **Display Info** window before the timeout period.

To set the timeout period, see [Display Notify \(page 72\)](#).

Adjusting the Contrast

1. Press the **Menu** button on the IR remote control. The **Output Setup** option will automatically be highlighted.

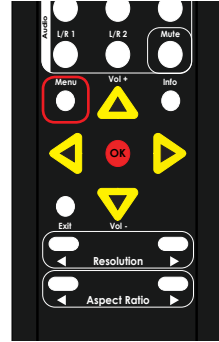
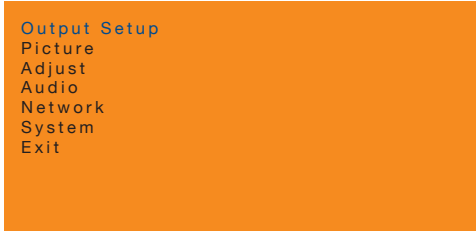

2. Press the **▲** or **▼** buttons to highlight the **Picture** option.

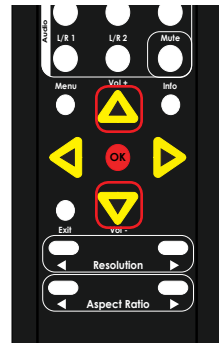
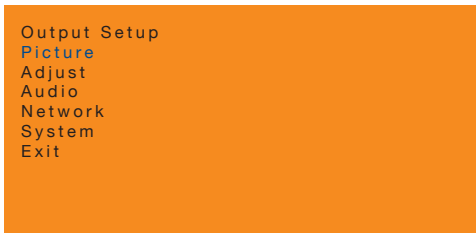

3. Press the **OK** button. The **Contrast** option will be highlighted.

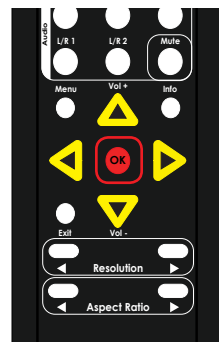
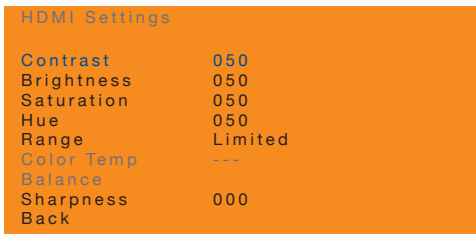

4. Press the **OK** button, again, to select the **Contrast** option.
5. The current contrast value will be highlighted in red.

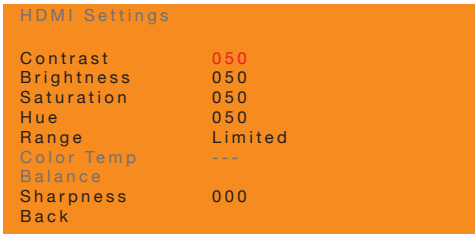

6. Press the **▲**, **▼**, **◀**, or **▶** buttons to select the desired contrast setting. The range is: 0 - 100.

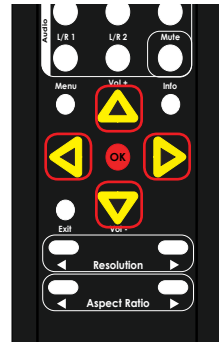
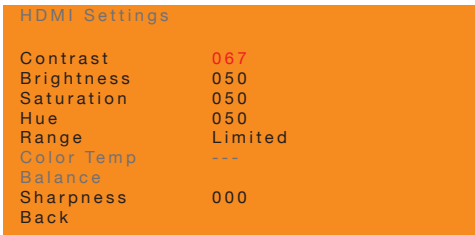

7. Press the **OK** button to accept the selected contrast setting.
8. To return to the previous menu, press the **▲** or **▼** buttons to highlight the **Back** option, then press the **OK** button. You can also press the **Menu** button to return to the top-level menu.

Adjusting the Brightness

1. Press the **Menu** button on the IR remote control. The **Output Setup** option will automatically be highlighted.

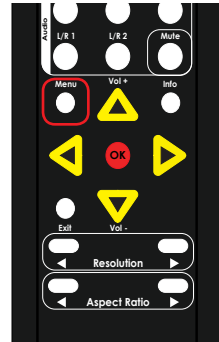

2. Press the **▲** or **▼** buttons to highlight the **Picture** option.

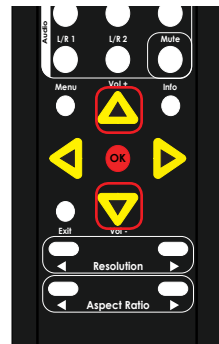
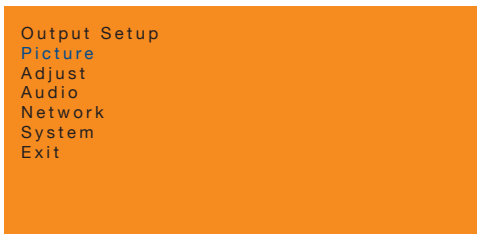

3. Press the **OK** button. The **Contrast** option will be highlighted.

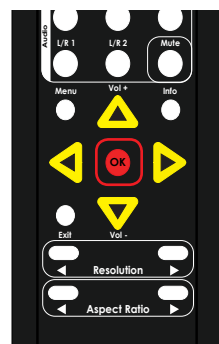
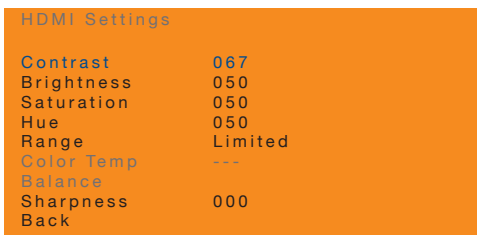

- Press the ▲ or ▼ buttons to highlight the **Brightness** option.

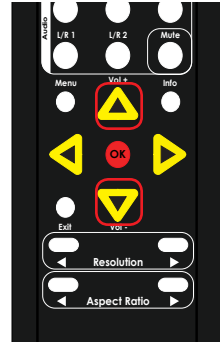
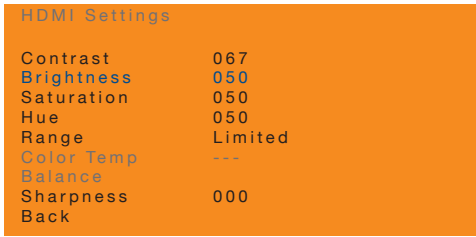

- Press the **OK** button to select the **Brightness** option.
- The current brightness value will be highlighted in red.
- Press the ▲, ▼, ◀, or ▶ buttons to set the desired brightness setting. The range is: 0 - 100.

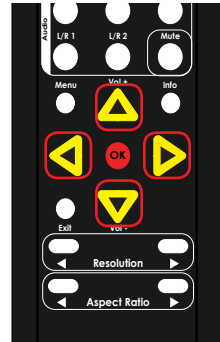
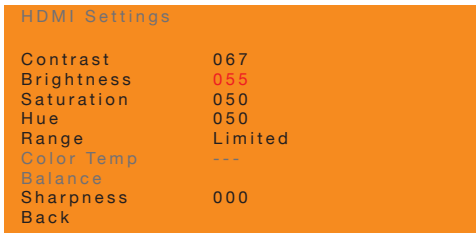

- Press the **OK** button to accept the desired brightness setting.
- To return to the previous menu, press the ▲ or ▼ buttons to highlight the **Back** option, then press the **OK** button. You can also press the **Menu** button to return to the top-level menu.

Adjusting the Saturation

1. Press the **Menu** button on the IR remote control. The **Output Setup** option will automatically be highlighted.

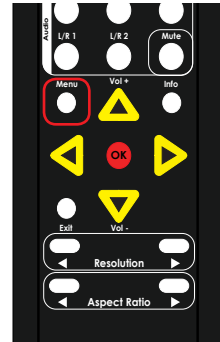
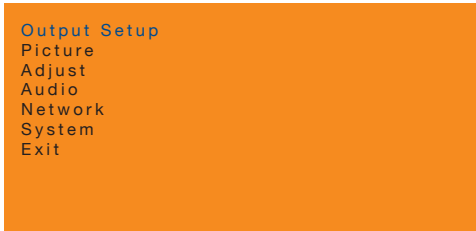

2. Press the **▲** or **▼** buttons to highlight the **Picture** option.

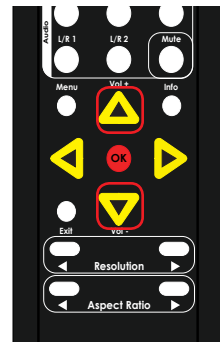
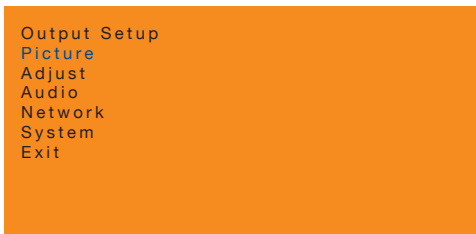

3. Press the **OK** button. The **Contrast** option will be highlighted.

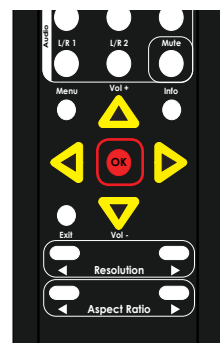
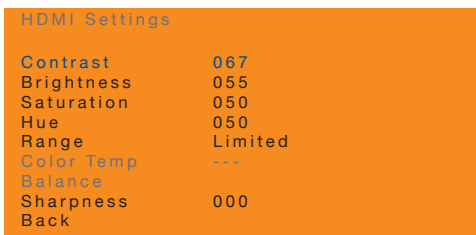

- Press the ▲ or ▼ buttons to highlight the **Saturation** option.

HDMI Settings	
Contrast	067
Brightness	055
Saturation	050
Hue	050
Range	Limited
Color Temp	---
Balance	
Sharpness	000
Back	

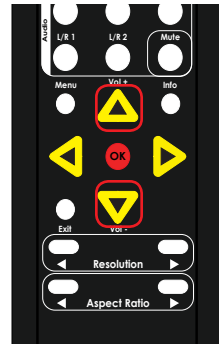

- Press the **OK** button to select the **Saturation** option.
- The current saturation value will highlighted in red.
- Press the ▲, ▼, ◀, or ▶ buttons to set the desired saturation setting.
The range is: 0 - 100.

HDMI Settings	
Contrast	067
Brightness	055
Saturation	048
Hue	050
Range	Limited
Color Temp	---
Balance	
Sharpness	000
Back	

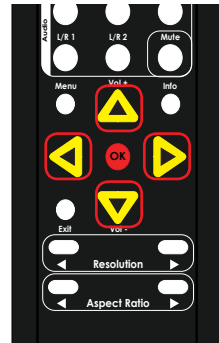

- Press the **OK** button to accept the desired saturation setting.
- To return to the previous menu, press the ▲ or ▼ buttons to highlight the **Back** option, then press the **OK** button. You can also press the **Menu** button to return to the top-level menu.

Adjusting the Hue

1. Press the **Menu** button on the IR remote control. The **Output Setup** option will automatically be highlighted.

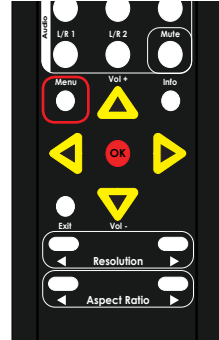

2. Press the **▲** or **▼** buttons to highlight the **Picture** option.

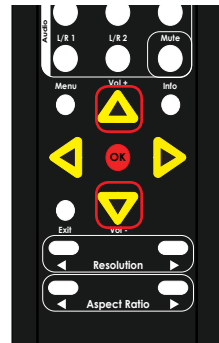
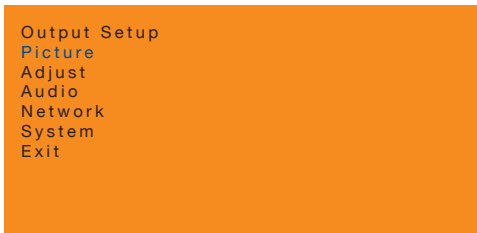

3. Press the **OK** button. The **Contrast** option will be highlighted.

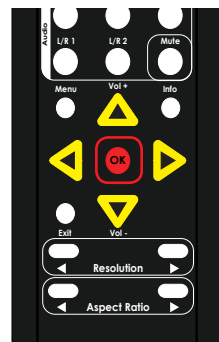
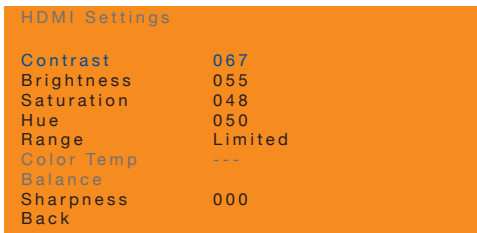

- Press the ▲ or ▼ buttons to highlight the **Hue** option.

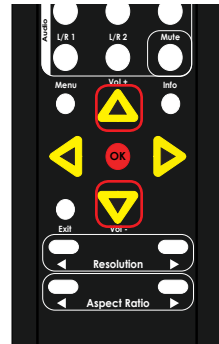
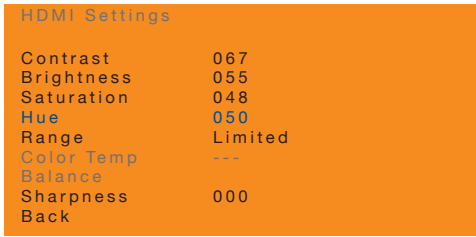

- Press the **OK** button to select the **Hue** option.
- The current hue value will be highlighted in red.
- Press the ▲, ▼, ◀, or ▶ buttons to set the desired hue setting. The range is: 0 - 100.

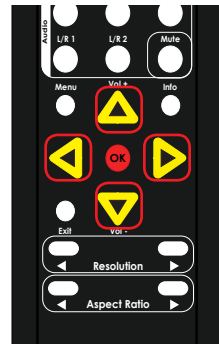
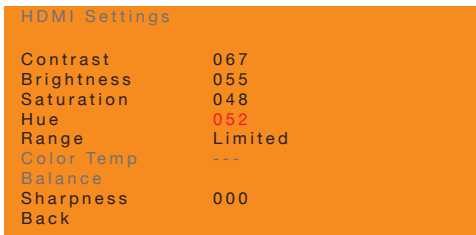

- Press the **OK** button to accept the desired hue setting.
- To return to the previous menu, press the ▲ or ▼ buttons to highlight the **Back** option, then press the **OK** button. You can also press the **Menu** button to return to the top-level menu.

Adjusting the Color Range

1. Press the **Menu** button on the IR remote control. The **Output Setup** option will automatically be highlighted.

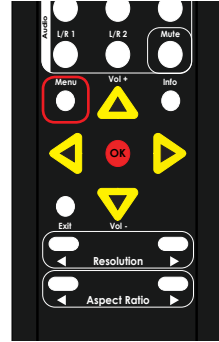
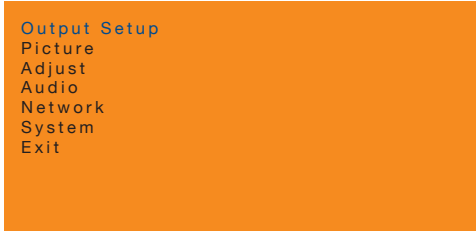

2. Press the **▲** or **▼** buttons to highlight the **Picture** option.

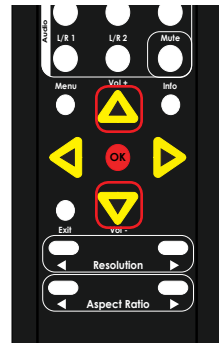
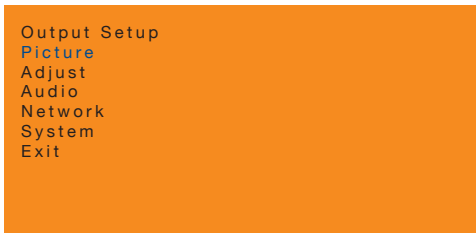

3. Press the **OK** button. The **Contrast** option will be highlighted.

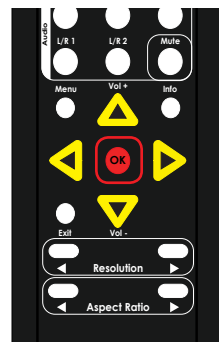
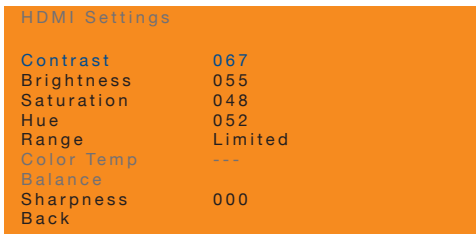

- Press the ▲ or ▼ buttons to highlight the **Range** option.

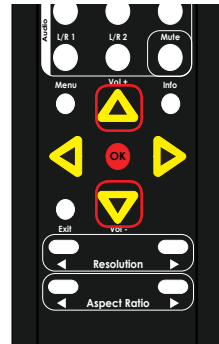
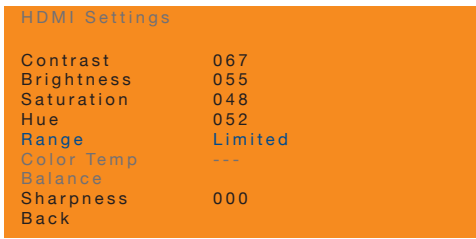

- Press the **OK** button to select the **Range** option.
- The current color range setting will be highlighted in red.
- Press the ▲, ▼, ◀, or ▶ buttons to switch between **Limited** or **Full**.

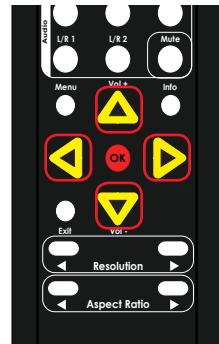
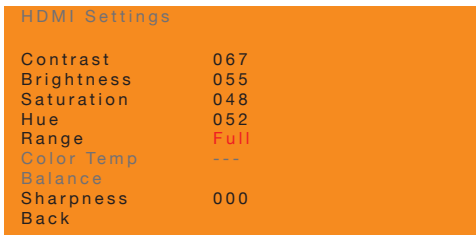

- Press the **OK** button to accept the desired color range setting.
- To return to the previous menu, press the ▲ or ▼ buttons to highlight the **Back** option, then press the **OK** button. You can also press the **Menu** button to return to the top-level menu.

Adjusting the Color Temperature



Information

The **Color Temperature** menu option is only available when using a VGA input signal.

1. Press the **Menu** button on the IR remote control. The **Output Setup** option will automatically be highlighted.

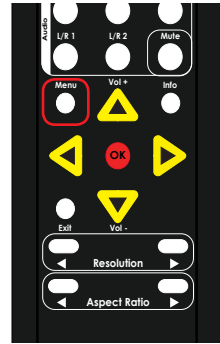

2. Press the **▲** or **▼** buttons to highlight the **Picture** option.

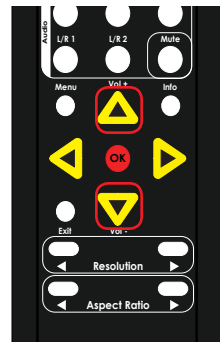
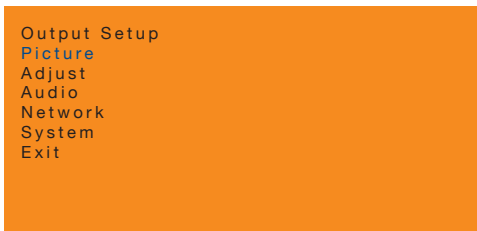

- Press the **OK** button. The **Contrast** option will be highlighted.

HDMI Settings	
Contrast	067
Brightness	055
Saturation	048
Hue	052
Range	Full
Color Temp	Neutral
Balance	
Sharpness	000
Back	

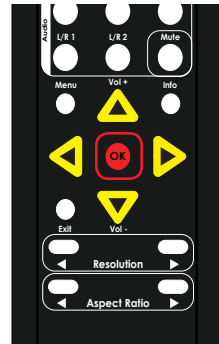

- Press the **▲** or **▼** buttons to highlight the **Color Temp** option.

HDMI Settings	
Contrast	067
Brightness	055
Saturation	048
Hue	052
Range	Full
Color Temp	Neutral
Balance	
Sharpness	000
Back	

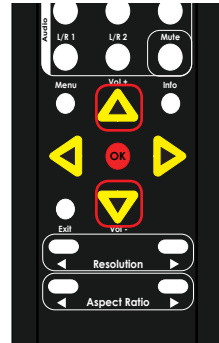

- Press the **OK** button to select the **Color Temp** option.
- The current color temperature setting will be highlighted in red.
- Press the **▲**, **▼**, **◀**, or **▶** buttons to switch between **Neutral**, **Warm**, **Cool**, and **User**.

HDMI Settings	
Contrast	067
Brightness	055
Saturation	048
Hue	052
Range	Full
Color Temp	Neutral
Balance	
Sharpness	000
Back	



- ▶ **Warm**
Shifts the picture color temperature toward “red” (~3,000K).
- ▶ **Cool**
Shifts the picture color temperature toward “blue” (~8,000K).
- ▶ **Neutral**
No change in picture color temperature.
- ▶ **User**
Allows the RGB values to be set individually. See [Adjusting the Color Balance \(page 34\)](#) for more information.

8. Press the **OK** button to accept the desired color range setting.

HDMI Settings	
Contrast	067
Brightness	055
Saturation	048
Hue	052
Range	Full
Color Temp	Warm
Balance	
Sharpness	000
Back	

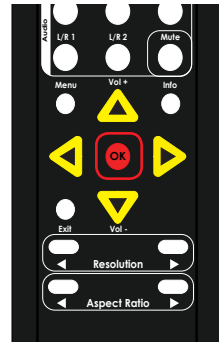

9. To return to the previous menu, press the **▲** or **▼** buttons to highlight the **Back** option, then press the **OK** button. You can also press the **Menu** button to return to the top-level menu.

Adjusting the Color Balance



Information

This menu option is only available if the **Color Temperature** is set to **User**. See *Adjusting the Color Temperature* (page 31) for more information.

1. Press the **Menu** button on the IR remote control. The **Output Setup** option will automatically be highlighted.

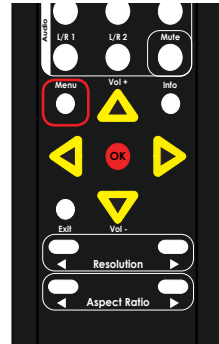
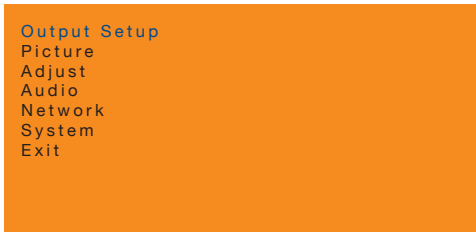

2. Press the **▲** or **▼** buttons to highlight the **Picture** option.

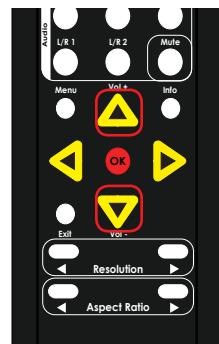
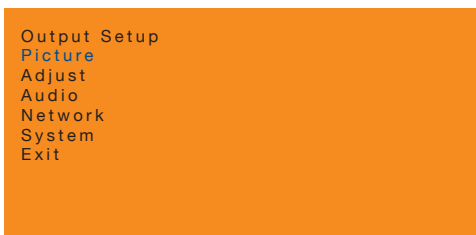

3. Press the **OK** button. The **Contrast** option will be highlighted.
4. Press the **▲** or **▼** buttons to highlight the **Color Temp** option.
5. Set the **Color Temp** option to **User**. See [Adjusting the Color Temperature \(page 31\)](#) for more information.
6. After setting the **Color Temp** option, return to this menu and press the **▲** or **▼** buttons to highlight the **Balance** option.

HDMI Settings	
Contrast	067
Brightness	055
Saturation	048
Hue	052
Range	Full
Color Temp	Warm
Balance	
Sharpness	000
Back	

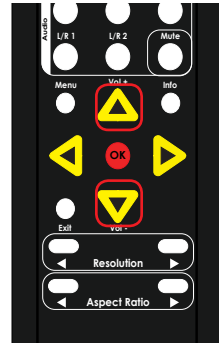

7. Press the **OK** button to select the **Balance** option.

HDMI Settings	
Contrast	067
Brightness	055
Saturation	048
Hue	052
Range	Full
Color Temp	Neutral
Balance	
Sharpness	000
Back	

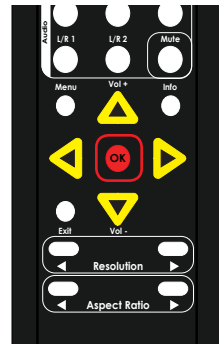

8. The current **Balance** screen will be displayed. Each color channel value is displayed. The **Red** option will be highlighted.

Red	050
Green	050
Blue	050
Back	

9. Press the ▲ or ▼ buttons to highlight the color channel to be changed.
10. Press the **OK** button to select the highlighted color channel. Once selected, the current value will be highlighted in red. In this example, we have selected the **Green** channel.

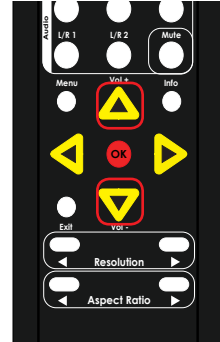
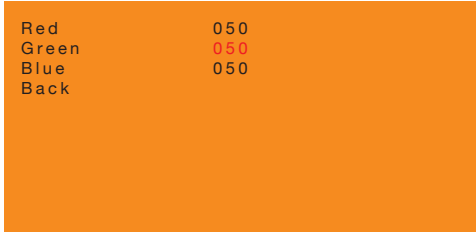

11. Press the ▲, ▼, ◀, or ▶ buttons to set the desired value for the color channel. The range for each color channel is: 0 - 100.

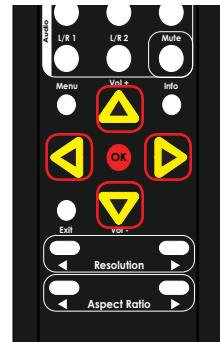
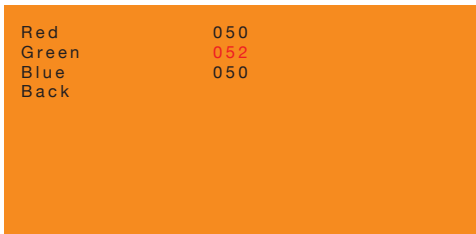

12. Press the **OK** button to accept the desired color channel setting.
13. Repeat steps 9 - 11 for each color channel, as desired.
14. To return to the previous menu, press the ▲ or ▼ buttons to highlight the **Back** option, then press the **OK** button. You can also press the **Menu** button to return to the top-level menu.

Adjusting the Sharpness

1. Press the **Menu** button on the IR remote control. The **Output Setup** option will automatically be highlighted.

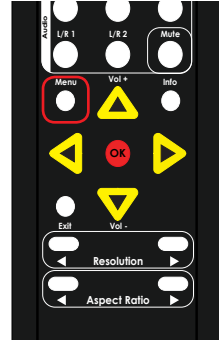

2. Press the **▲** or **▼** buttons to highlight the **Picture** option.

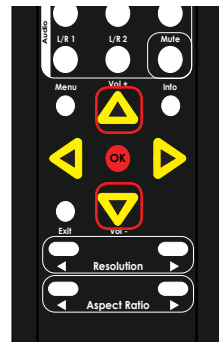
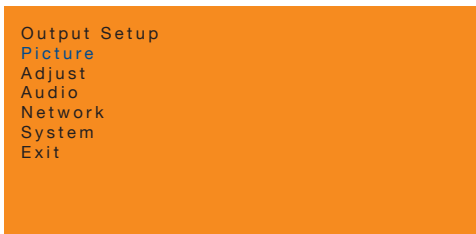

3. Press the **OK** button. The **Contrast** option will be highlighted.

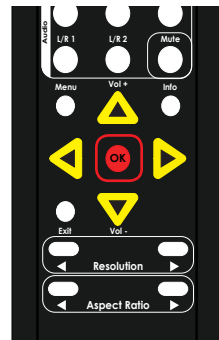
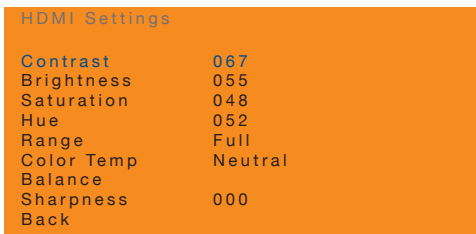

- Press the ▲ or ▼ buttons to highlight the **Sharpness** option.

HDMI Settings	
Contrast	067
Brightness	055
Saturation	048
Hue	052
Range	Full
Color Temp	User
Balance	
Sharpness	000
Back	

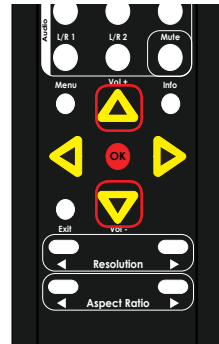

- Press the **OK** button to select the **Sharpness** option.
- The current sharpness setting will be highlighted in red.
- Press the ▲, ▼, ◀, or ▶ buttons to set the sharpness setting. The range is: 0 - 100.

HDMI Settings	
Contrast	067
Brightness	055
Saturation	048
Hue	052
Range	Full
Color Temp	User
Balance	
Sharpness	025
Back	

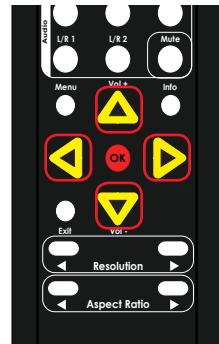

- Press the **OK** button to accept the desired sharpness setting.
- To return to the previous menu, press the ▲ or ▼ buttons to highlight the **Back** option, then press the **OK** button. You can also press the **Menu** button to return to the top-level menu.

Using Auto Size

The Auto Size feature automatically adjusts the clock and phase of the incoming VGA signal. If the alignment of the picture is incorrect then use this feature to correct it.



Information

The **Autosize** menu option is only available when using a VGA input signal.

1. Press the **Menu** button on the IR remote control. The **Output Setup** option will automatically be highlighted.

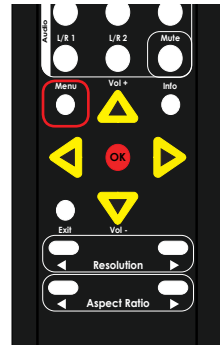
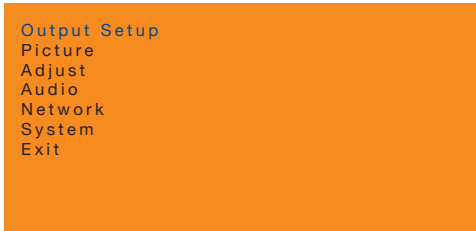

2. Press the **▲** or **▼** buttons to highlight the **Adjust** option.

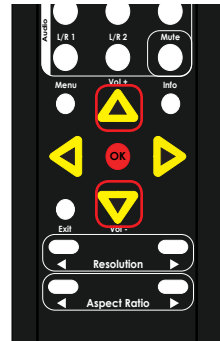
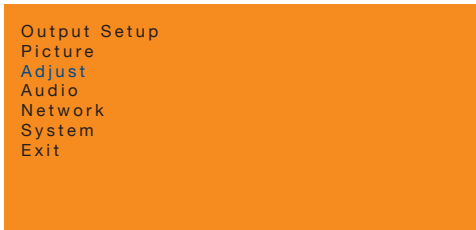

3. Press the **OK** button to display the **VGA Settings**.
4. The **Auto Size** option will be highlighted.

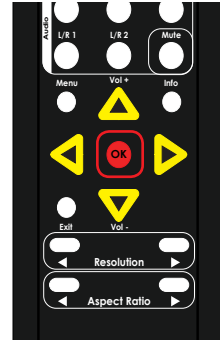
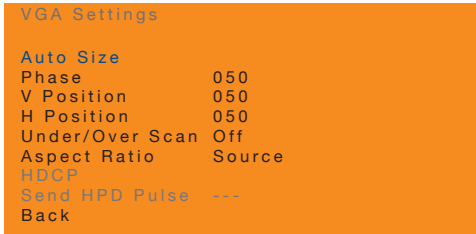

5. Press the **OK** button, again, to activate the **Auto Size** feature.
6. The word "Executing" will be displayed, in red, next to the **Auto Size** feature.

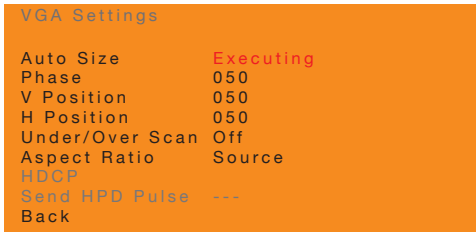

This process is instantaneous and once completed, the "Executing" message will disappear.

7. To return to the previous menu, press the **▲** or **▼** buttons to highlight the **Back** option, then press the **OK** button. You can also press the **Menu** button to return to the top-level menu.

Adjusting the Phase



Information

The **Phase** menu option is only available when using a VGA input signal.

1. Press the **Menu** button. The **Output Setup** option will automatically be highlighted.

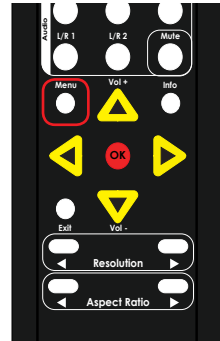

2. Press the **▲** or **▼** buttons to highlight the **Adjust** option.

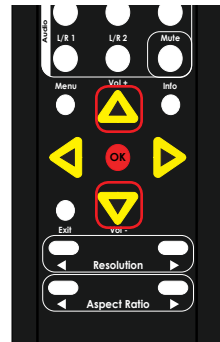
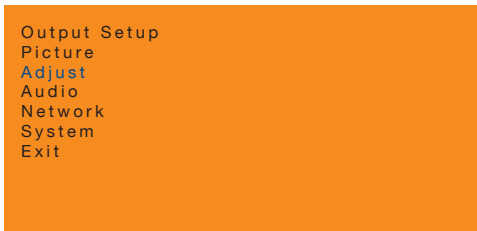

- Press the **OK** button to display the **VGA Settings**. The **Auto Size** option will be highlighted.

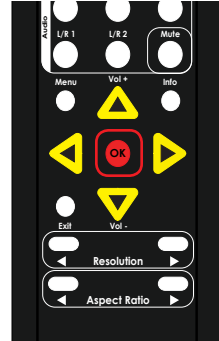
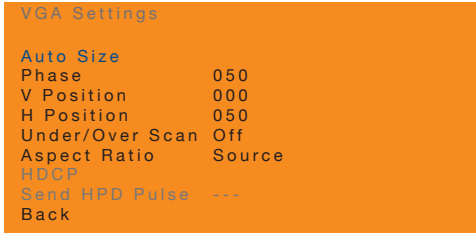

- Press the **▲** or **▼** buttons to highlight the **Phase** option.
- Press the **OK** button, again, to activate the **Phase** feature.
- The current phase value will be highlighted in red.

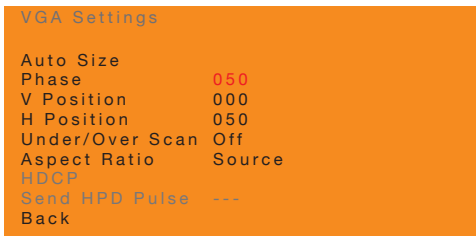

- Press the **▲**, **▼**, **◀**, or **▶** buttons to set the desired phase setting. The range is: 0 - 100.

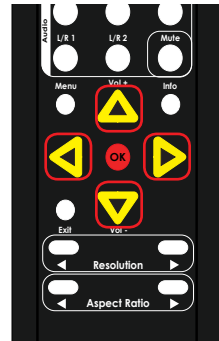
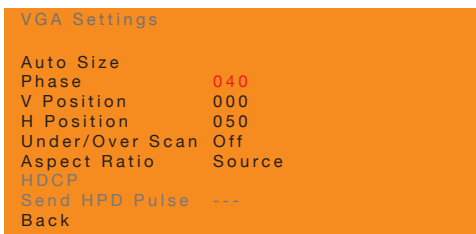

8. Press the **OK** button to accept the desired phase setting.

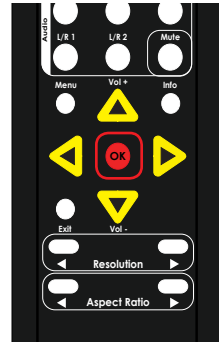
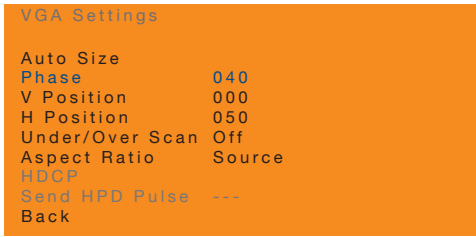

9. To return to the previous menu, press the **▲** or **▼** buttons to highlight the **Back** option, then press the **OK** button. You can also press the **Menu** button to return to the top-level menu.

Adjusting the Vertical Position



Information

The **V Position** menu option is only available when using a VGA input signal.

1. Press the **Menu** button. The **Output Setup** option will automatically be highlighted.

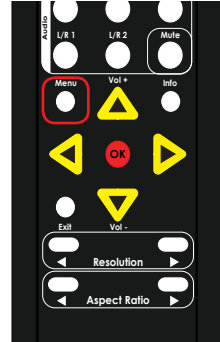
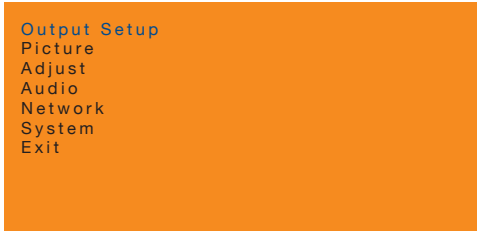

2. Press the **▲** or **▼** buttons to highlight the **Adjust** option.

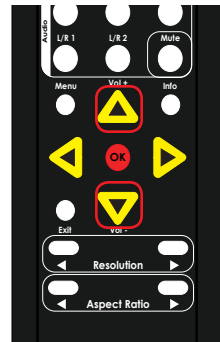
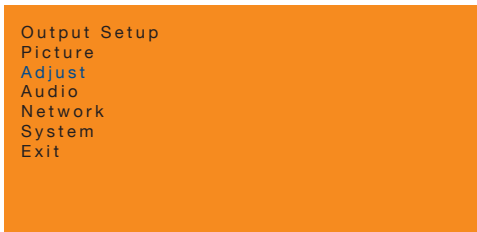

- Press the **OK** button to display the **VGA Settings**. The **Auto Size** option will be highlighted.

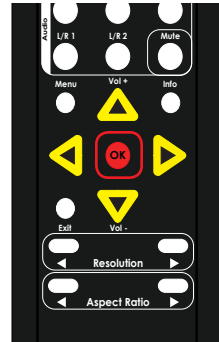
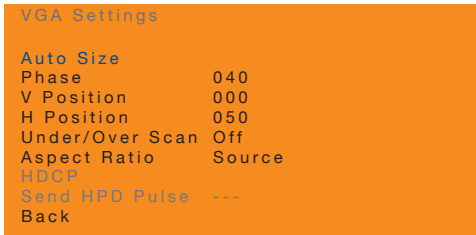

- Press the **▲** or **▼** buttons to highlight the **V Position** option.
- Press the **OK** button, again, to activate the **V Position** option.
- The current vertical position value will be highlighted in red.

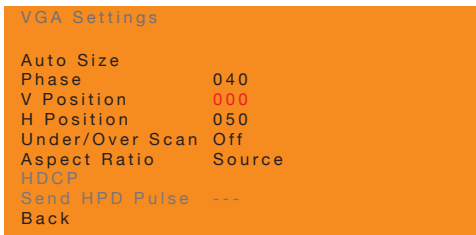

- Press the **▲**, **▼**, **◀**, or **▶** buttons to set the desired phase setting. The range is: 0 - 100. Increasing the value will move the image, up, vertically.

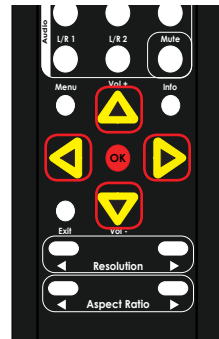
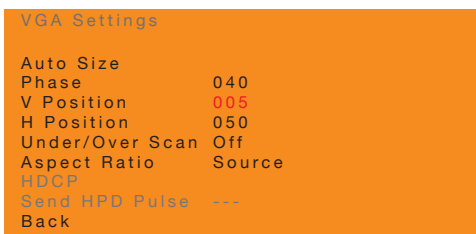

8. Press the **OK** button to accept the desired vertical position setting.

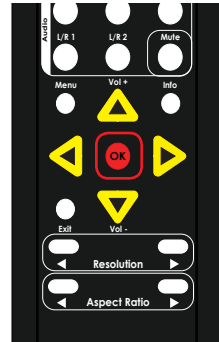
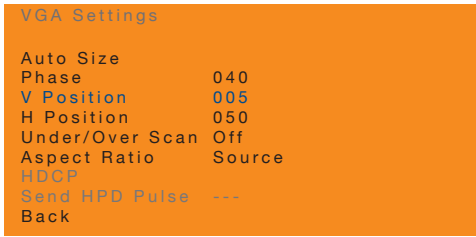

9. To return to the previous menu, press the **▲** or **▼** buttons to highlight the **Back** option, then press the **OK** button. You can also press the **Menu** button to return to the top-level menu.

Adjusting the Horizontal Position



Information

The **H Position** menu option is only available when using a VGA input signal.

1. Press the **Menu** button. The **Output Setup** option will automatically be highlighted.

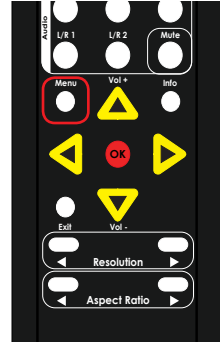
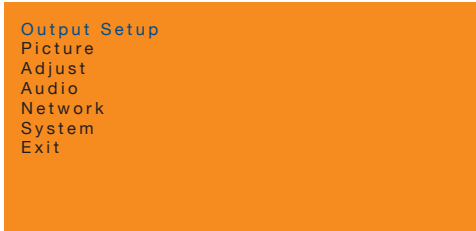

2. Press the **▲** or **▼** buttons to highlight the **Adjust** option.

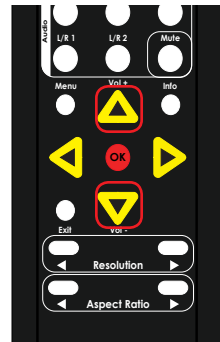

- Press the **OK** button. The **Auto Size** option will be highlighted.

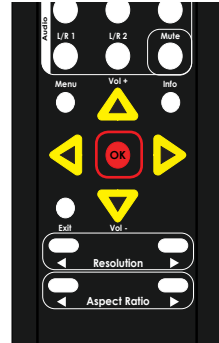
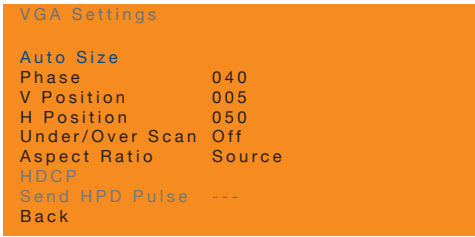

- Press the **▲** or **▼** buttons to highlight the **H Position** option.
- Press the **OK** button, again, to activate the **H Position** option.
- The current horizontal position value will be highlighted in red.

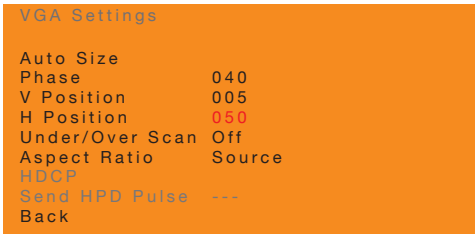

- Press the **▲**, **▼**, **◀**, or **▶** buttons to set the desired phase setting. The range is: 0 - 100. Values less than 50 will shift the picture to the left. Values greater than 50 will shift the picture to the right.

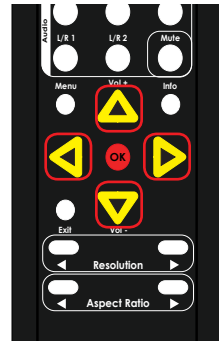
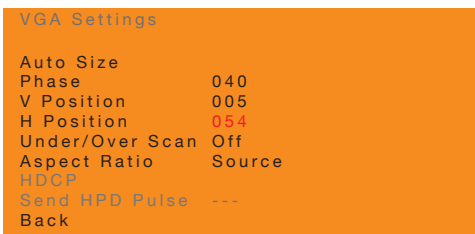

8. Press the **OK** button to accept the desired vertical position setting.

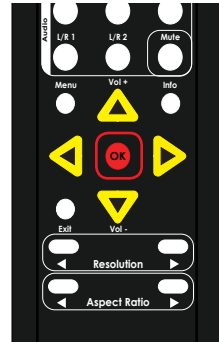
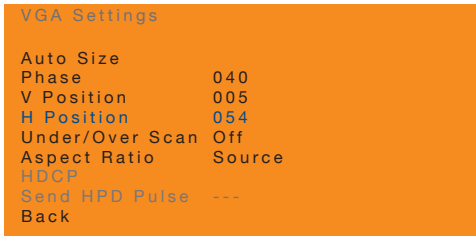

9. To return to the previous menu, press the **▲** or **▼** buttons to highlight the **Back** option, then press the **OK** button. You can also press the **Menu** button to return to the top-level menu.

Adjusting Underscan / Overscan

1. Press the **Menu** button. The **Output Setup** option will automatically be highlighted.

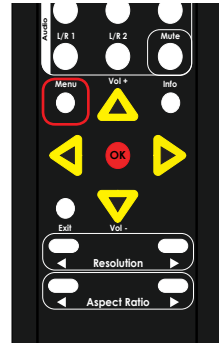
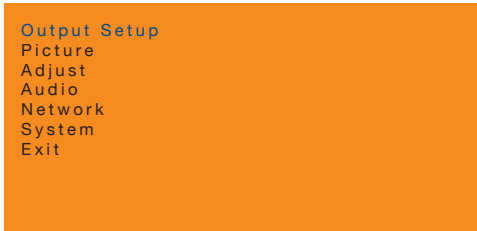

2. Press the **▲** or **▼** buttons to highlight the **Adjust** option.

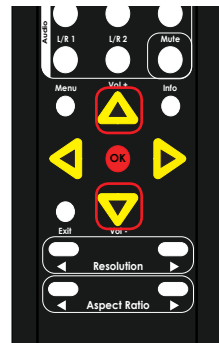
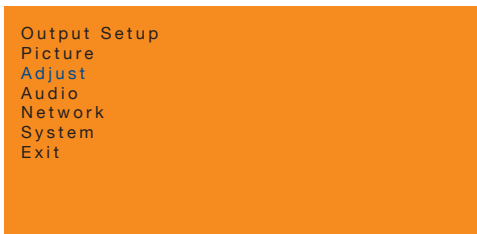

3. Press the **OK** button. The **Auto Size** option will be highlighted.

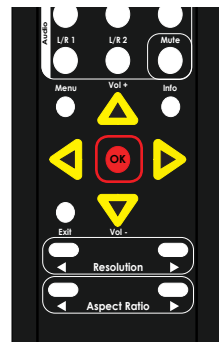
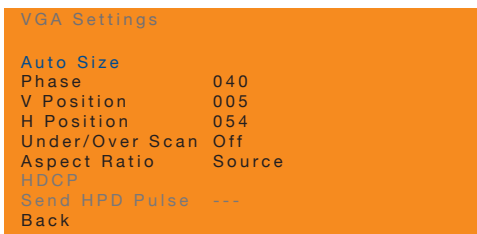

4. Press the ▲ or ▼ buttons to highlight the **Under/Over Scan** option.
5. Press the **OK** button, again, to activate the **Under/Over Scan** option.
6. The current value will highlighted in red.

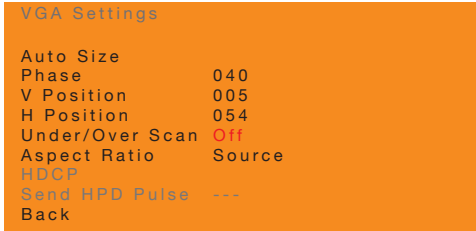

7. Press the ▲, ▼, ◀, or ▶ buttons to set the desired setting.

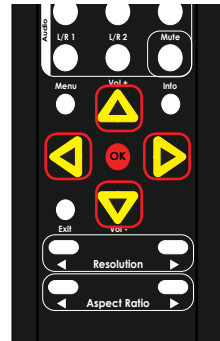
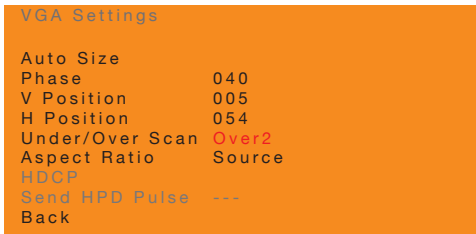

- ▶ **Off**
No underscan / overscan applied. This is the default setting.
- ▶ **Under1, Under2, Under3**
Applies underscan values of 3%, 6%, and 9% respectively.
- ▶ **Over1, Over2, Over3**
Applies overscan values of 3%, 6%, and 9% respectively.

- Press the **OK** button to accept the desired setting.

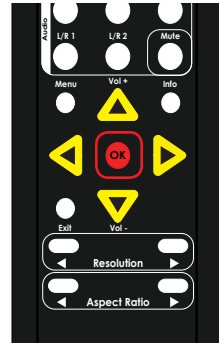
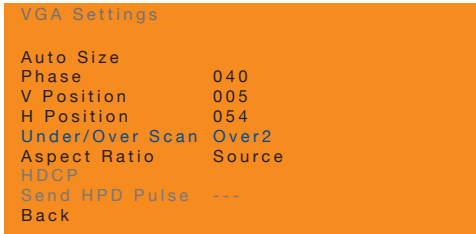

- To return to the previous menu, press the **▲** or **▼** buttons to highlight the **Back** option, then press the **OK** button. You can also press the **Menu** button to return to the top-level menu.

Adjusting the Aspect Ratio

1. Press the **Menu** button. The **Output Setup** option will automatically be highlighted.

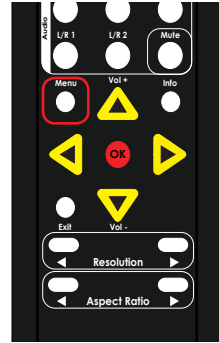
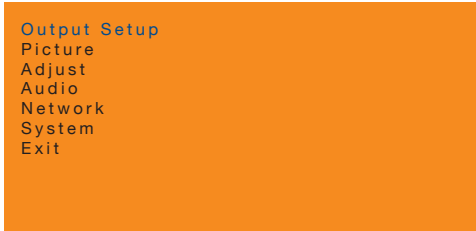

2. Press the **▲** or **▼** buttons to highlight the **Adjust** option.

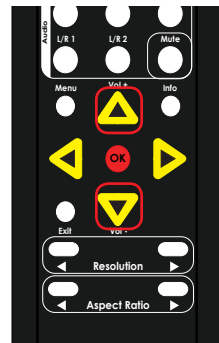
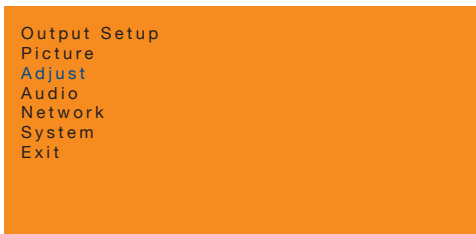

3. Press the **OK** button. The **Auto Size** option will be highlighted.

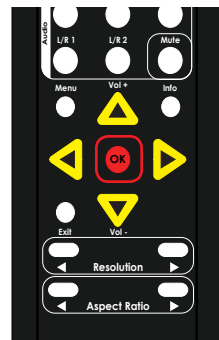
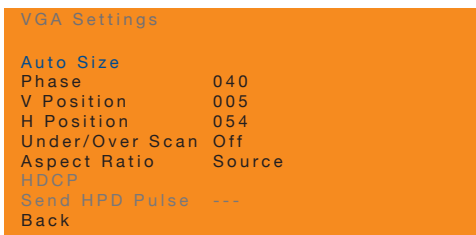

4. Press the ▲ or ▼ buttons to highlight the **Aspect Ratio** option.
5. Press the **OK** button, again, to activate the **Aspect Ratio** option.
6. The current value will highlighted in red.

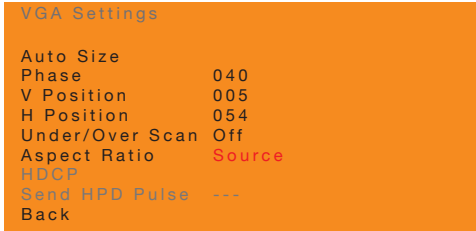

7. Press the ▲, ▼, ◀, or ▶ buttons to set the desired setting.

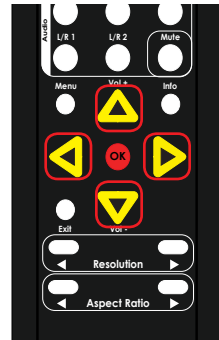
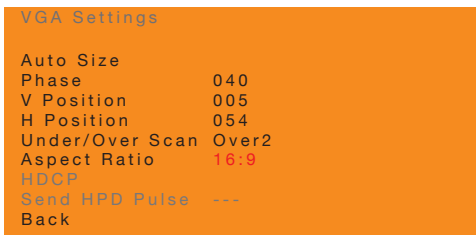

- ▶ **Source**
The output signal uses the same aspect ratio as the input signal. This is the default setting.
- ▶ **16:9**
Sets the aspect ratio to 16:9 format.
- ▶ **4:3**
Sets the aspect ratio to 4:3 format. Depending upon the input signal and the display that is used, applying this aspect ratio may cause a loss of up to 12% in the output signal.
- ▶ **Stretch**
Pixels on the input signal are stretched to fit the screen area of the display.

- Press the **OK** button to accept the desired setting.

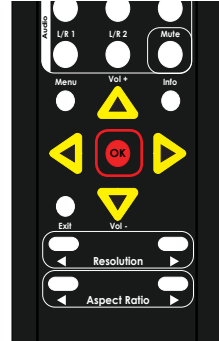
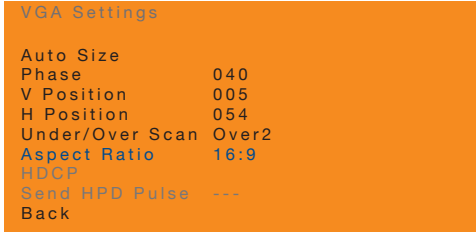

Note that the aspect ratio can also be changed by pressing the ◀ or ▶ **Aspect Ratio** buttons.

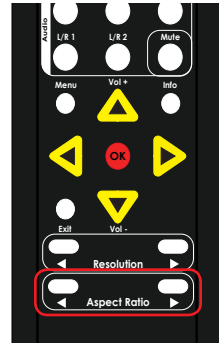

- To return to the previous menu, press the ▲ or ▼ buttons to highlight the **Back** option, then press the **OK** button. You can also press the **Menu** button to return to the top-level menu.

HDCP

Some sources (e.g. computers) will enable HDCP if an HDCP-compliant display is detected. The HDMI input can be set to **On** or **Off**. If set to **On**, the HDCP is passed through. If set to **Off**, then HDCP content will not be accepted.



Information

The **HDCP** menu option is only available when using an HDMI input signal. This feature does not allow HDCP to be defeated.

1. Press the **Menu** button. The **Output Setup** option will automatically be highlighted.

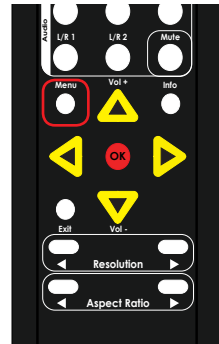
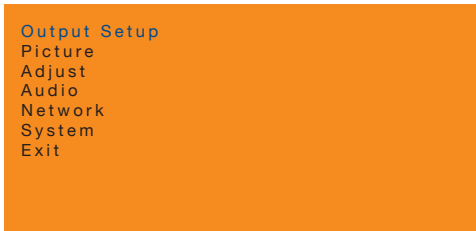

2. Press the **▲** or **▼** buttons to highlight the **Adjust** option.

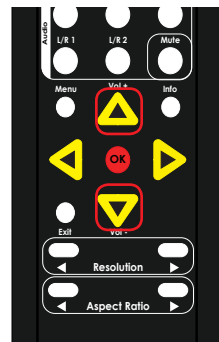
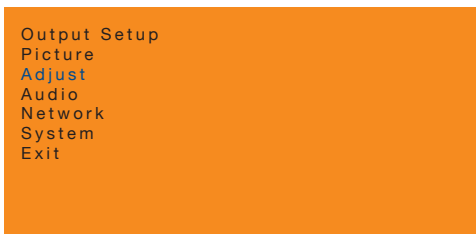

- Press the **OK** button. The **Under/Over Scan** option will be highlighted.

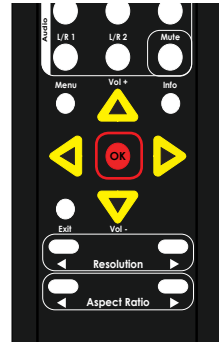
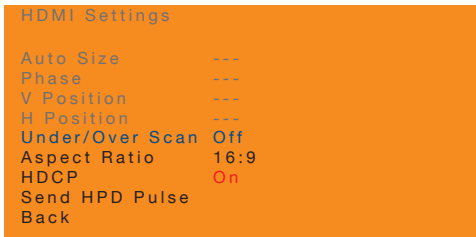

- Press the **▲** or **▼** buttons to highlight the **HDCP** option.
- Press the **OK** button, again, to activate the **HDCP** option.
- The current value will be highlighted in red.

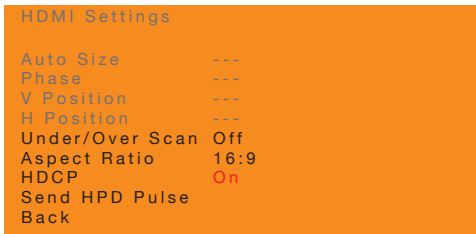

- Press the **▲**, **▼**, **◀**, or **▶** buttons to switch between **On** or **Off**.

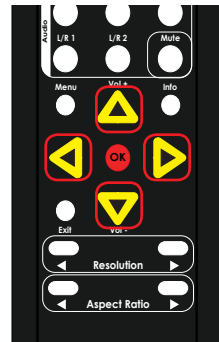
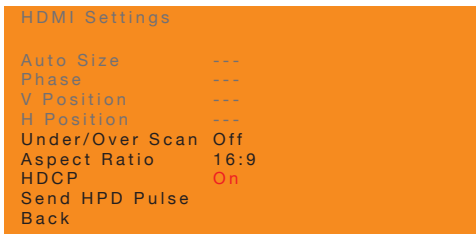

8. Press the **OK** button to accept the desired setting.

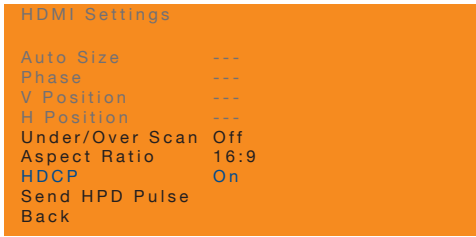

9. To return to the previous menu, press the **▲** or **▼** buttons to highlight the **Back** option, then press the **OK** button. You can also press the **Menu** button to return to the top-level menu.

Sending an HPD Pulse

Sending an HPD (Hot-Plug Detect) signal pulse cycles the HPD line on the input. Performing this function is identical to physically disconnecting and reconnecting the cable between the source and the Multi-Format Processor.



Information

The **Send HPD Pulse** menu option is only available when using an HDMI input signal.

1. Press the **Menu** button. The **Output Setup** option will automatically be highlighted.

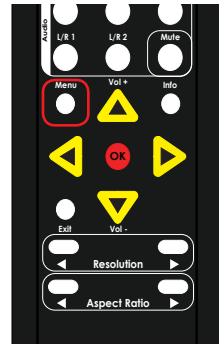
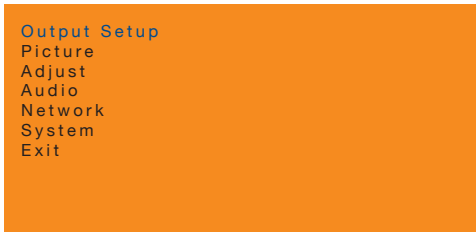

2. Press the **▲** or **▼** buttons to highlight the **Adjust** option.

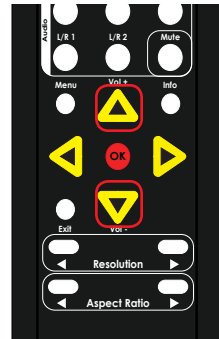
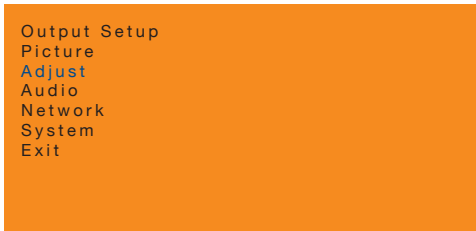

3. Press the **OK** button. The **Under/Over Scan** option will be highlighted.

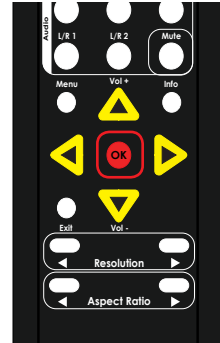
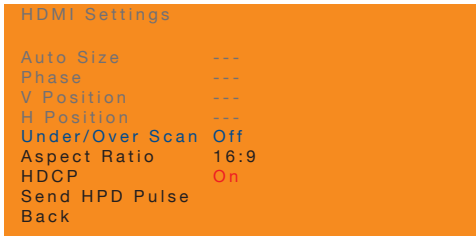

4. Press the **▲** or **▼** buttons to highlight the **Send HPD Pulse** option.
5. Press the **OK** button, again, to select the **Send HPD Pulse** option.
6. The word "Send" will appear, in red, next to the **Send HPD Pulse** option.

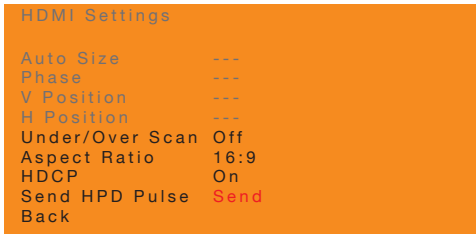

7. Press the **OK** button, again, to activate the **Send HPD Pulse** option.
8. The screen will flash and after a few moments, the image will be displayed.
9. To return to the previous menu, press the **▲** or **▼** buttons to highlight the **Back** option, then press the **OK** button. You can also press the **Menu** button to return to the top-level menu.

Enabling / Disabling Analog Audio Output

1. Press the **Menu** button. The **Output Setup** option will automatically be highlighted.

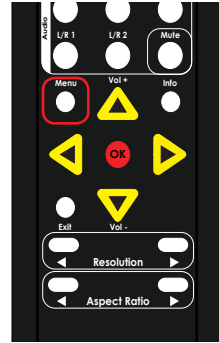
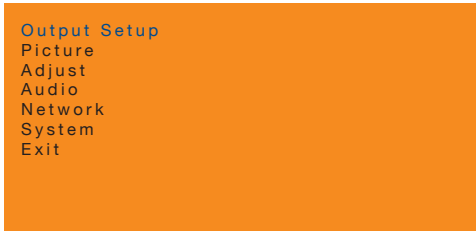

2. Press the **▲** or **▼** buttons to highlight the **Audio** option.

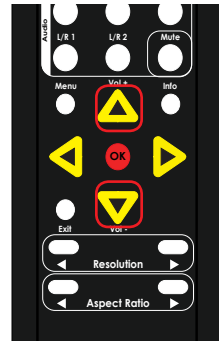
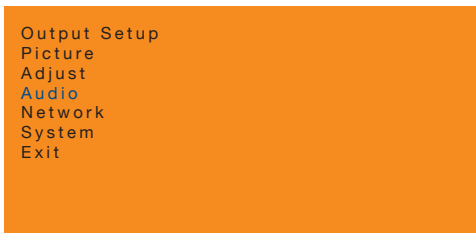

3. Press the **OK** button. The **Analog Out** option will be highlighted.

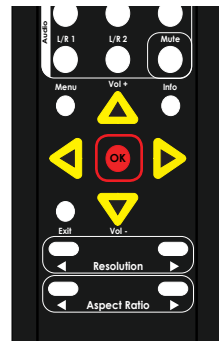
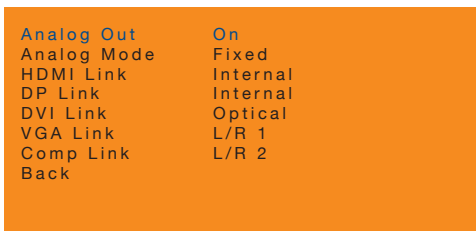

3. Press the **OK** button, again, to select the **Analog Out** option.
4. Press the **▲**, **▼**, **◀**, or **▶** buttons to switch between **On** or **Off**.
 - ▶ **On**
Enables audio on the Analog Out ports.
 - ▶ **Off**
Disables audio on the Analog Out ports.

Analog Out	On
Analog Mode	Fixed
HDMI Link	Internal
DP Link	Internal
DVI Link	Optical
VGA Link	L/R 1
Comp Link	L/R 2
Back	

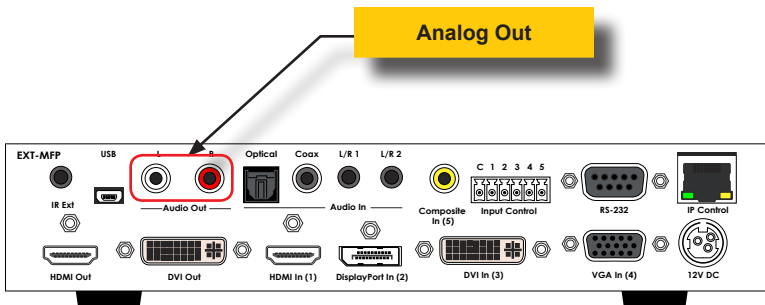
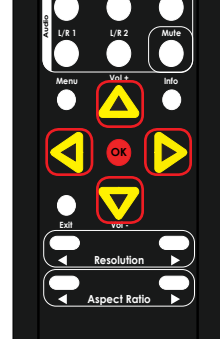

5. Press the **OK** button to accept the desired setting.
6. To return to the previous menu, press the **▲** or **▼** buttons to highlight the **Back** option, then press the **OK** button. You can also press the **Menu** button to return to the top-level menu.

Setting the Analog Audio Mode

1. Press the **Menu** button. The **Output Setup** option will automatically be highlighted.

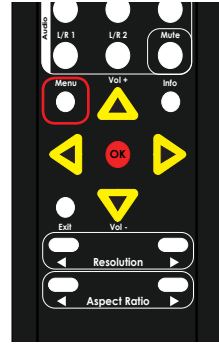
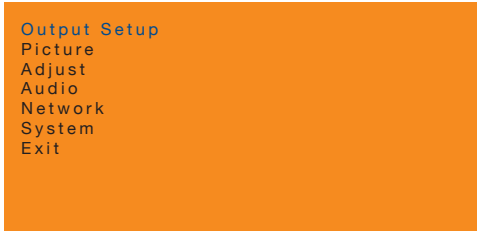

2. Press the **▲** or **▼** buttons to highlight the **Audio** option.

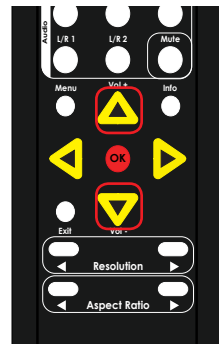
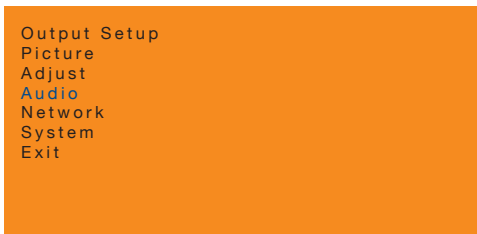

3. Press the **OK** button. The **Analog Out** option will be highlighted.

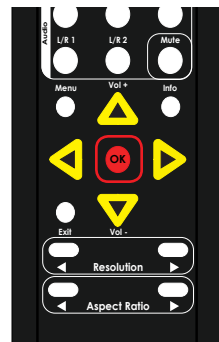
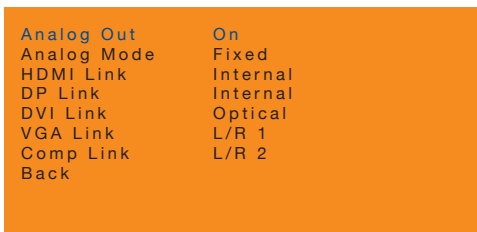

- Press the ▲ or ▼ buttons to highlight the **Analog Mode** option.

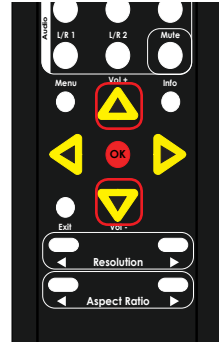
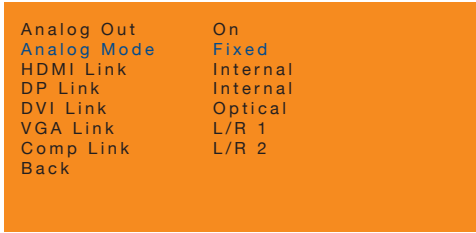

- Press the **OK** button, again, to select the **Analog Mode** option.
- Press the ▲, ▼, ◀, or ▶ buttons to switch between **Fixed** or **Variable**.
 - ▶ **Fixed**
The Multi-Format Processor will control the audio output level. This is the default setting.
 - ▶ **Variable**
The source device controls the audio output level.

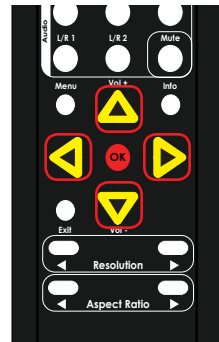
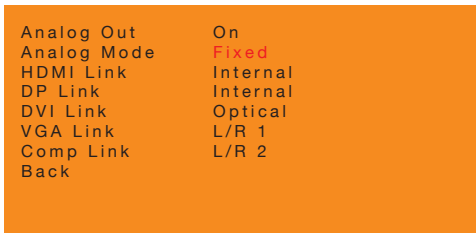

- Press the **OK** button to accept the desired setting.
- To return to the previous menu, press the ▲ or ▼ buttons to highlight the **Back** option, then press the **OK** button. You can also press the **Menu** button to return to the top-level menu.

Audio Linking

The linking feature of the Multi-Format Process allows each video input to be assigned a separate audio source. If the **No Audio** setting is used, then the audio will be muted on the selected video input. If the **No Change** setting is used, then this will prevent the audio source from changing when switching video inputs. See [Setup ► Audio \(page 90\)](#), within the built-in Web interface, for more information.

1. Press the **Menu** button. The **Output Setup** option will automatically be highlighted.

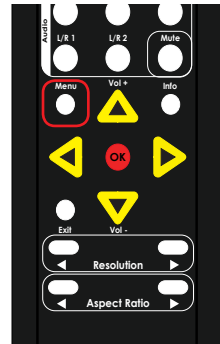
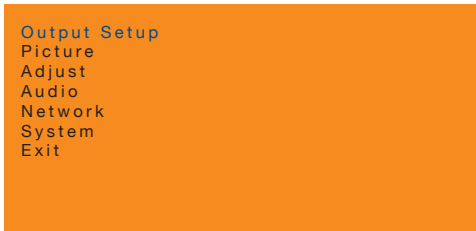

2. Press the **▲** or **▼** buttons to highlight the **Audio** option.

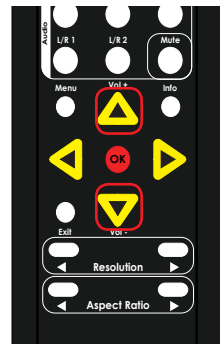
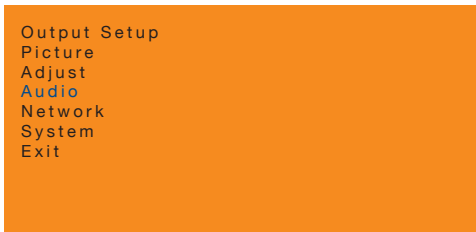

3. Press the **OK** button. The **Analog Out** option will be highlighted.

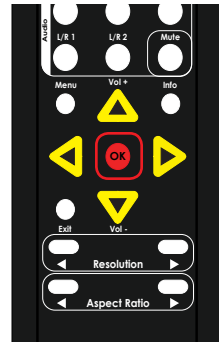
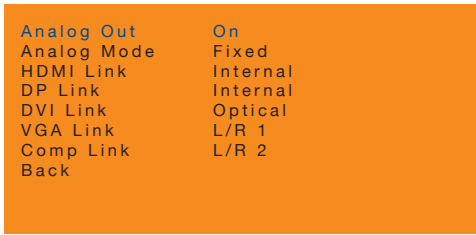

4. Press the **▲** or **▼** buttons to highlight the desired video port modify audio linking. The table, below, lists the available audio inputs for each video input.

Audio	HDMI	DisplayPort	DVI	VGA	Composite
Internal	Yes	Yes	Yes*	No	No
Optical	Yes	Yes	Yes	Yes	Yes
Coaxial	Yes	Yes	Yes	Yes	Yes
L/R 1	Yes	Yes	Yes	Yes	Yes
L/R 2	Yes	Yes	Yes	Yes	Yes
No Audio	Yes	Yes	Yes	Yes	Yes
No Change	Yes	Yes	Yes	Yes	Yes

* Only if signal is HDMI.

5. Press the **OK** button, again, to select the highlighted video port. The audio setting for the port will be highlighted in red, as shown in the example below.

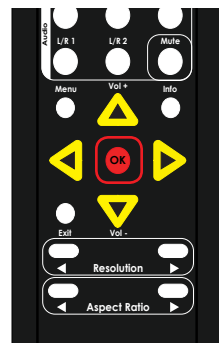
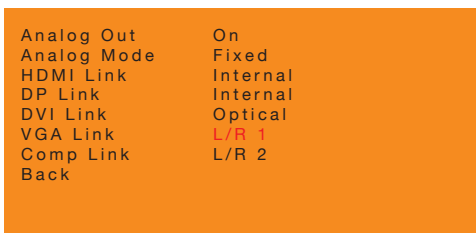

6. Press the ▲, ▼, ◀, or ▶ buttons to switch to the desired audio input.

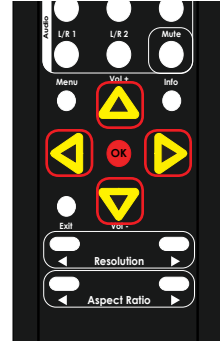
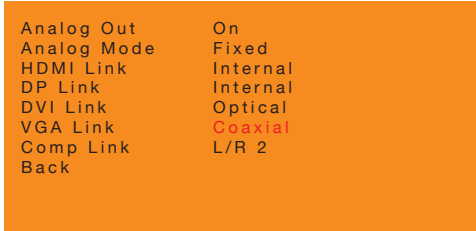

7. Press the **OK** button to accept the desired setting.
8. To return to the previous menu, press the ▲ or ▼ buttons to highlight the **Back** option, then press the **OK** button. You can also press the **Menu** button to return to the top-level menu.

Changing the IP Settings

1. Press the **Menu** button. The **Output Setup** option will automatically be highlighted.

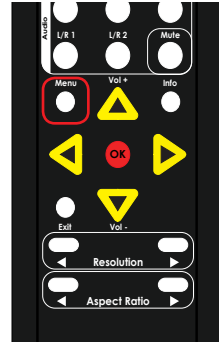
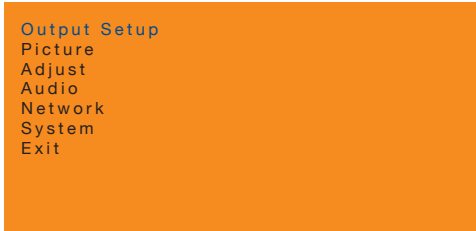

2. Press the **▲** or **▼** buttons to highlight the **Network** option.

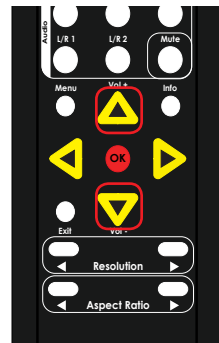
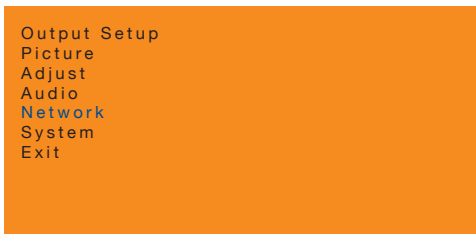

3. Press the **OK** button. The **IP Mode** option will be highlighted.

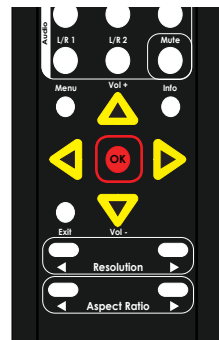
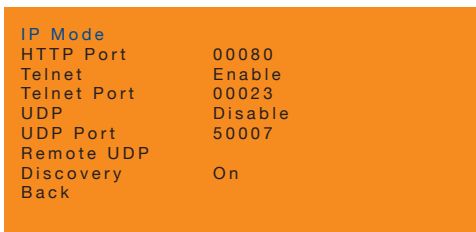

4. Press the ▲ or ▼ buttons to highlight the desired option.

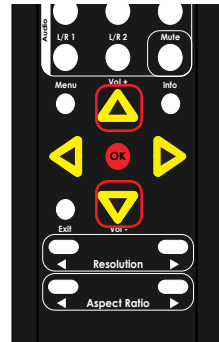
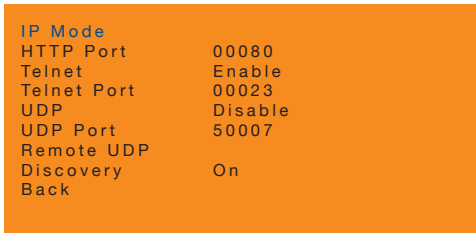

5. Press the **OK** button to select the highlighted option.

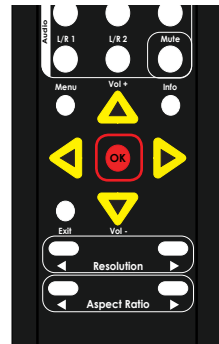
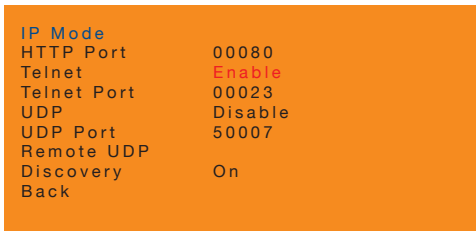

- ▶ To modify **Telnet**, **UDP**, and **Discovery** options:
 - a. Press the **OK** button to select the option.
 - b. Press the ▲, ▼, ◀, or ▶ buttons to switch between **Enable / Disable** or **On / Off**, depending upon the options that are available.
 - c. Press the **OK** button to save the change.

- ▶ To modify **HTTP Port**, **Telnet Port**, or **UDP Port** options:
 - a. Press the **OK** button to select the option.
 - b. Press the ◀ or ▶ buttons to select the digit.
 - c. Press the ▲ or ▼ buttons to select the numeric value (0 - 9).
 - d. Press the **OK** button to save the change.

- ▶ To set the **IP Mode** option(s):
 - a. Press the **OK** button to select **IP Mode**.
 - b. The following screen will be displayed:

IP Mode	Static
Static IP	
IP Address	: 192.168.001.072
Subnet Mask	: 255.255.255.000
Def Gateway	: 192.168.001.001
IP Address	: 192.168.001.072
Mac Address	: 00:1C:91:04:50:D6
Back	

- c. Press the **▲** or **▼** buttons to highlight the desired option.
 - d. Press the **OK** button to select the highlighted option.
 - e. To change the **IP Mode** option:
 - i. Select the **IP Mode** option.
 - ii. Press **▲**, **▼**, **◀**, or **▶** buttons to switch between **Static** or **DHCP**.
 - iii. Press the **OK** button to save the change.
 - f. To change the **IP Address**, **Subnet Mask**, or **Def Gateway** options:
 - vii. Press the **OK** button to select the desired option.
 - viii. Press the **◀** or **▶** buttons to select the digit.
 - ix. Press the **▲** or **▼** buttons to select the numeric value (0 - 9).
 - x. Press the **OK** button to save the change.
6. To return to the previous menu, press the **▲** or **▼** buttons to highlight the **Back** option, then press the **OK** button. You can also press the **Menu** button to return to the top-level menu.

Changing the System Settings

1. Press the **Menu** button. The **Output Setup** option will automatically be highlighted.

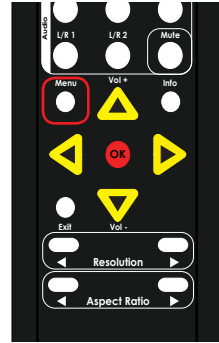
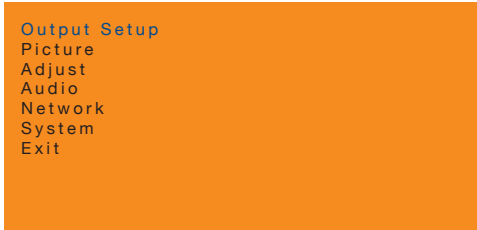

2. Press the **▲** or **▼** buttons to highlight the **System** option.

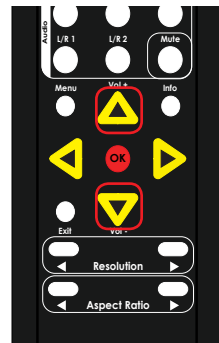
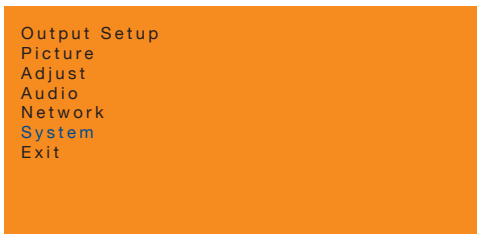

3. Press the **OK** button. The **OSD** option will be highlighted.

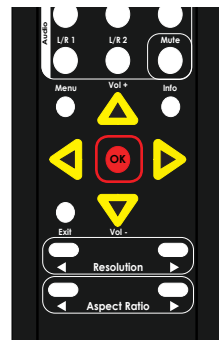
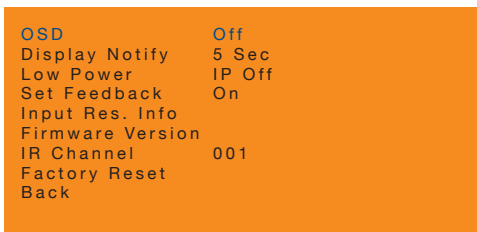

4. Press the ▲ or ▼ buttons to highlight the desired option.
5. Press the **OK** button to select it.
6. Press the ▲, ▼, ◀, or ▶ buttons to set the desired value.

OSD	Off
Display Notify	5 Sec
Low Power	IP Off
Set Feedback	On
Input Res. Info	
Firmware Version	
IR Channel	001
Factory Reset	
Back	

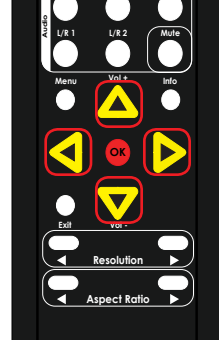

OSD Timeout

Sets the timeout value of the OSD after the **Menu** button is pressed. Set the value to **Off** to prevent the OSD from timing out. Set a value from 5 to 60 (in seconds) to set the timeout period.

Display Notify

If set to **Off**, the Display Notify window is never displayed. Set to **On** to always display the window. Set to **005** to set the timeout value to 5 seconds.



Lower Power

Turns off IP Control. This meets EnergyStar requirements, but does not allow the unit to be turned on using IP control. Set this option to **IP Off** only if you are NOT using IP control.

Set Feedback

Enables or disables feedback for RS-232, UDP, and Telnet. If set to **Off**, then feedback will be turned off for compatibility with one-way control systems.

Input Res. Info

Displays the current input resolution / timing and color space information. To return to the **System** menu, press the **Menu** button.

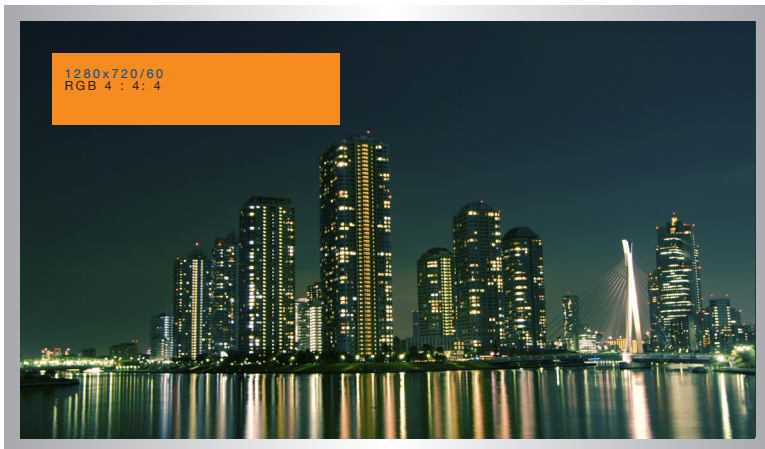

Firmware Version

Displays the current input resolution / timing and color space information. To return to the **System** menu, press the **Menu** button.

FIRMWARE VERSION IS 1.37

Multi-Format Processor IR Channel

Set the IR channel for the Multi-Format Processor. The IR channel for both the Multi-Format Processor and the IR remote control must be the same. See [Setting the IR Channel \(page 8\)](#) for more information.

Factory Reset

Set the Multi-Format Processor to factory-default settings. See [Default Settings \(page 238\)](#) for a list of factory-default settings.

Contact Control

You can select inputs using ordinary dry-contact push-button switches, keypads, or contact closures. Any device that provides a simple normally-open (NO) momentary closure can be wired to the **Input Control** connectors on the rear panel, using the included screw-terminal connecting block. Video inputs (with associated audio) can be selected by connecting SPST NO switches between the desired input and the “C” terminal. Refer to the illustration below.

1. Connect switches between the desired input selection (1 - 5) and the “C” terminal as shown below. The numbers correspond to the video inputs as follow:
 1. HDMI
 2. DisplayPort
 3. DVI
 4. VGA
 5. Composite Video
2. Closing the connection momentarily will cause the Multi-Format Processor to select that video input. If configured, the audio input will also change to the pre-set linked audio input. See [Setup ▶ Audio \(page 90\)](#) for more information on audio selection.

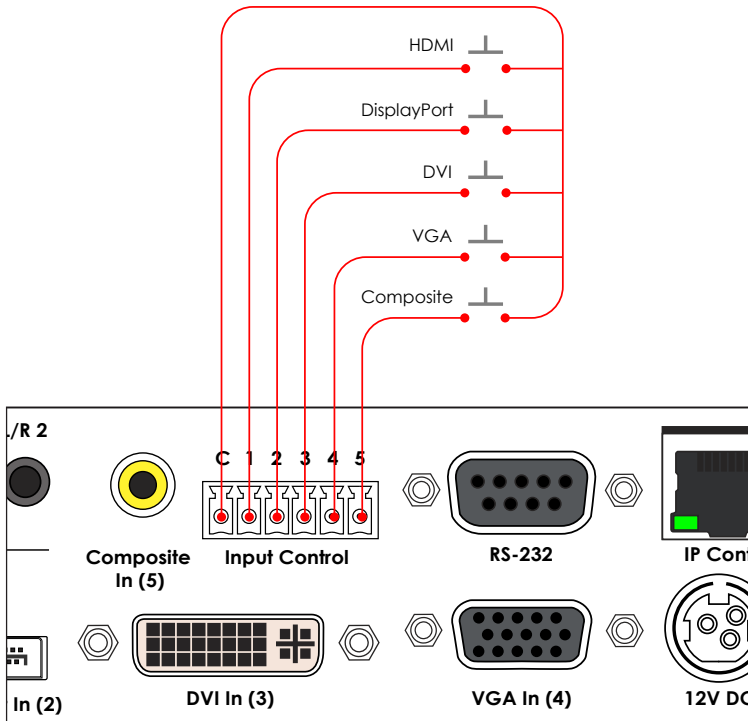

RS-232 Control

You can control the Multi-Format Processor with any control device that can send simple ASCII commands over RS-232. Connect a serial cable with a DB-9M connector to the **RS-232** port on the rear panel. See page [RS-232 Interface \(page 114\)](#) for more information.

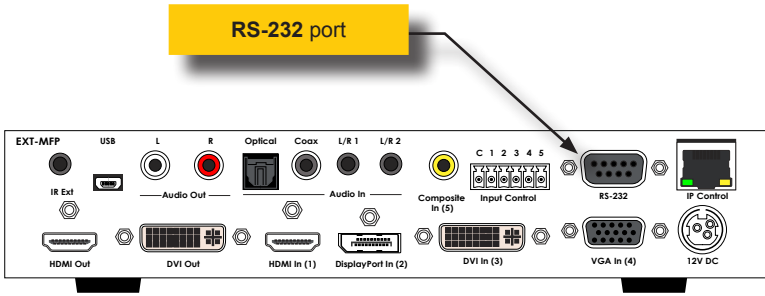

IP Control

You can also control the Multi-Format Processor with any control device or system that can send Telnet commands to the IP address of the Multi-Format Processor. Connect a LAN Patch Cord with an RJ-45 connector to the **IP Control** Port on the rear panel. See [IP Configuration \(page 115\)](#) for more information.

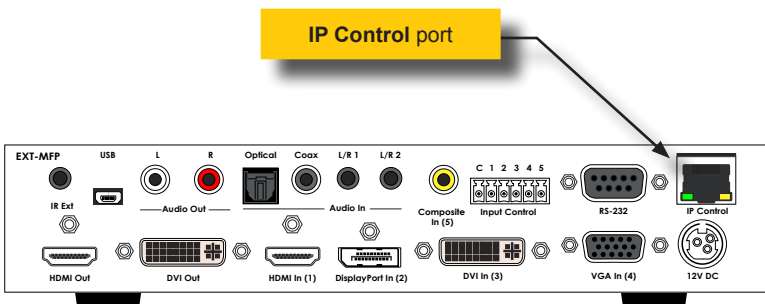

Gefen's new **Syner-G Discovery Tool** makes it easy to set up IP Control for your Multi-Format Processor!

With the **Syner-G Discovery Tool**, you don't need to be an IT Expert to set up a new network device. You can easily configure or operate your Multi-Function Processor from any Windows PC, laptop, iOS or Android smart phone or tablet.

Gefen Syner-G Software Suite is a free download from www.gefen.com/synerg, or you can download the free **Syner-G Discovery Tool App** from the Apple App Store or the Google Play Store.

Download the App or the software and install it on your PC, laptop, or smart phone.

Make sure your PC or phone is on the same network that the Multi-Format Processor is connected to and that the Multi-Format Processor is connected to power.

Syner-G Software Suite

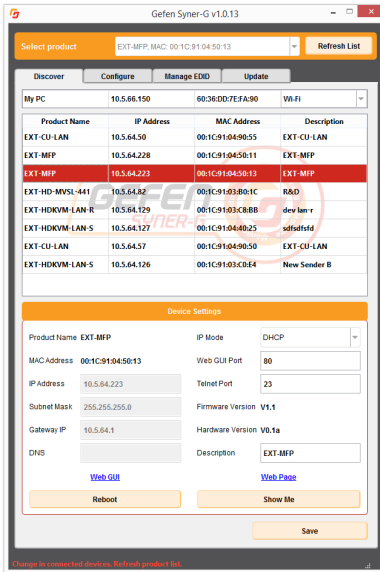

Syner-G Discovery App



(continued on next page)

Using the Gefen Syner-G Discovery Tool

1. Make sure that the **Enable Discovery** feature is set to *enabled*. See [Network Discovery Protocol Settings \(page 106\)](#) for more information on this feature.



Information

If the Multi-Format Processor is in *standby mode* and set to "Low Power", then the Multi-Format Processor will not be detected by Syner-G. See the [System \(page 108\) Web page section](#) for more information.

2. Open the software suite and click the **Discover** tab or open the App and press **Find Devices On Network**.
3. The **Product Name** of the Multi-Format Processor will be displayed as **EXT-MFP**.
4. Click on the **EXT-MFP**.
5. The Device IP Settings will appear at the bottom of the screen (shown on the next page).

The screenshot shows the Gefen Syner-G v1.0.13 software interface. At the top, there is a 'Select product' dropdown menu with 'EXT-MFP MAC: 00:1C:91:04:59:13' selected and a 'Refresh List' button. Below this is a navigation bar with tabs for 'Discover', 'Configure', 'Manage EDID', and 'Update'. The main area displays a table of discovered devices. The table has columns for 'Product Name', 'IP Address', and 'MAC Address'. The 'EXT-MFP' device is highlighted in red, and a yellow callout box points to its 'Product Name' field.

Product Name	IP Address	MAC Address	Description
EXT-CU-LAN	10.5.64.50	00:1C:91:04:90:55	EXT-CU-LAN
EXT-MFP	10.5.64.228	00:1C:91:04:50:11	EXT-MFP
EXT-MFP	10.5.64.223	00:1C:91:04:50:13	EXT-MFP
EXT-HD-MVSL-441	10.5.64.82	00:1C:91:03:80:1C	R&D
EXT-HDKVM-LAN-R	10.5.64.129	00:1C:91:03:C8:BB	dev lan r
EXT-HDKVM-LAN-S	10.5.64.127	00:1C:91:04:60:25	sdhdata
EXT-CU-LAN	10.5.64.57	00:1C:91:04:90:50	EXT-CU-LAN

- The current IP Address and settings are displayed. You can change the settings if necessary to allow other users to easily connect to the Multi-Format Processor.

Device Settings		Description field
Product Name	EXT-MFP	IP Mode: DHCP
MACAddress	00:1C:91:04:50:13	Telnet Port: 80
IP Address	10.5.64.223	Firmware Version: V1.1
Subnet		Hardware Version: V0.1a
Gateway IP	10.5.64.1	Description: EXT-MFP
DNS		
Web GUI Reboot		Web Page Show Me

- The text in the **Description** field can be changed to help identify a specific unit if there are several Multi-Format Processors connected on a network. By default, the Product Name is used as the Description.
- Press the **Show Me** button. When the **Show Me** button is pressed, the **Audio** and **Video** LED indicators on the front panel of the Multi-Format Processor will flash green..This behavior indicates that you are connected to the correct device.
- Press the **Web GUI** link to go directly to the built-in Multi-Format Processor Web interface.

Note that if the IP address of the Multi-Format Processor is not compatible with your network settings, then you will be unable to access the Web interface. You can change the IP settings of the Multi-Format Processor on this page and then try again to connect.

- Type the password (default Operator password is “operator”) to access the control screen. See [Using the Built-in Web Interface \(page 80\)](#) for more information.

Using the Built-in Web Interface

The built-in Web interface provides advanced control of the Multi-Format Processor. In order to access the Web interface use the Gefen Syner-G Software Suite to obtain the IP settings of the Multi-Format Processor. Once connected to the Multi-Format Processor, the login screen will be displayed.

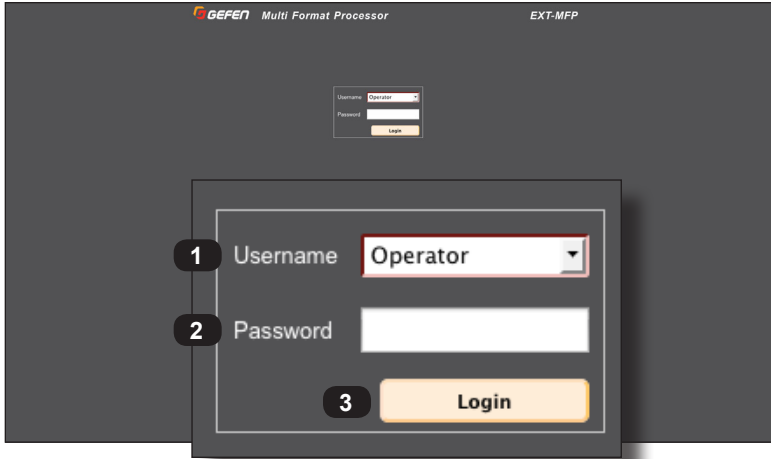

ID	Name	Description
1	Username	Select the username from the drop-down list. The <code>Administrator</code> login provides unrestricted access to all features and settings. <code>Operator</code> login limits access to routing, display information, and routing preset features.
2	Password	Enter the password for the associated username. The password can also be set using the <code>#set_webui_ad_pass</code> and <code>#set_webui_op_pass</code> commands, respectively. The password is masked when it is entered. <ul style="list-style-type: none"> The default <code>Operator</code> password is <code>Operator</code>. The default <code>Administrator</code> password is <code>Admin</code>.
3	Login	Click this button to login in to the Web interface.

The Web interface is divided into six main pages: **Main**, **Status**, **Setup**, **Manage EDID**, **Network**, and **System**. Each main page is represented by a tab at the top-most portion of the screen. The **Setup** and **Manage EDID** pages have their own set of sub-tabs. Click on the desired tab / sub-tab to open the desired page.

Information

In order to view all six tabs, the user must be logged-in as "Administrator". If logged-in as "Operator", then only the **Main** tab will be visible.

Main

1

Video Select

1 BluRay 2 Laptop 3 Cable 4 Computer 5 Camera No Video

HDMI (Internal) DisplayPort (Internal) DVI (Coaxial) VGA (L/R 2) Composite (No Change) No Video

2

Audio Select

Cable CD Sonos Computer Boombox No Audio

The screenshot shows the 'Main' tab of the GEFEN Multi Format Processor web interface. At the top, there are navigation tabs: Main, Status, Setup, Manage EDID, Network, and System. The 'Main' tab is active. Below the tabs, there are two rows of selection buttons. The first row is labeled 'Video Select' and contains six buttons: 1 BluRay (HDMI Internal), 2 Laptop (DisplayPort Internal), 3 Cable (DVI Coaxial), 4 Computer (VGA L/R 2), 5 Camera (Composite No Change), and No Video. The second row is labeled 'Audio Select' and contains six buttons: Cable (Internal), CD (Optical), Sonos (Coaxial), Computer (L/R 1), Boombox (L/R 2), and No Audio. The 'DVI (Coaxial)' and 'Coaxial' buttons are highlighted in orange. On the right side of the interface, there are controls for 'EXT-MFP' including 'Power On/Off', 'Volume' (set to 40), and 'Mute' (set to Off). The interface also displays 'Input Resolution' (1920x1080@24/30/60Hz) and 'Output Resolution' (1440x1080@60Hz).

ID	Name	Description
1	Video Select	Click these buttons to switch to the desired video input. <i>Options:</i> HDMI, DisplayPort, DVI, VGA, Composite, No Video
2	Audio Select	Click these buttons to switch to the desired audio input. <i>Options:</i> Internal, Optical, Coaxial, L/R 1, L/R 2, No Audio

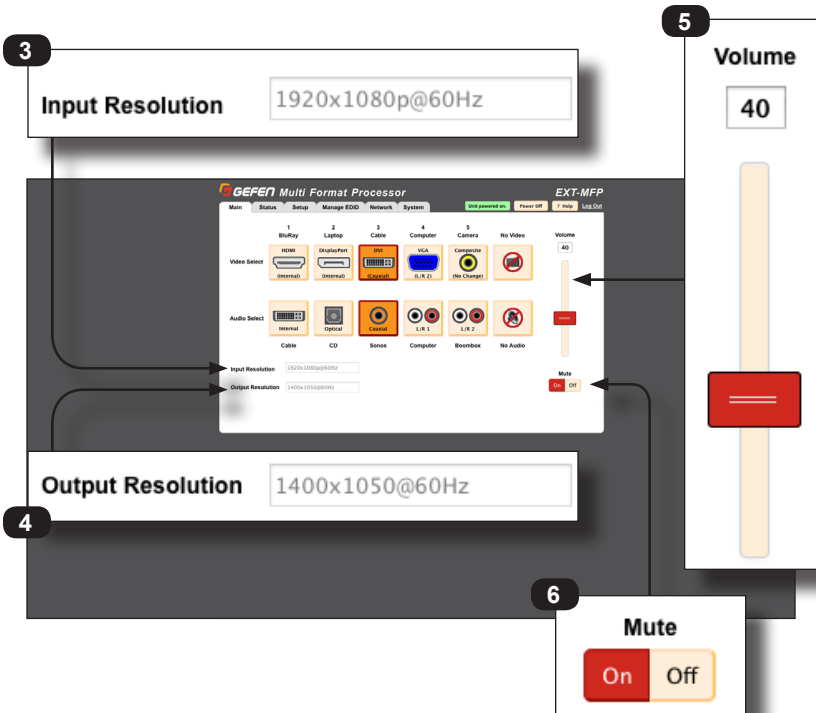

ID	Name	Description
3	Input Resolution	Displays the input resolution of the source.
4	Output Resolution	Displays the output resolution from the Multi-Format Processor.
5	Volume (Analog audio output only)	Click and drag the slider control to adjust the volume to the desired output level. The volume level can also be set by entering the desired level in the Volume box. The current volume level is listed in the box above the slider bar.
6	Mute	Click the On button to mute the audio output. Click the Off button to restore the audio level to the previous state. The button that is highlighted in red will indicate the current muting state.

Status

1 **Output**

Name	HDMI	DVI
RSENSE	Off	On
Mask	Off	On
HPD	High	Low
HDCP	Active	Inactive

2 **Input**

Name	HDMI
Audio Input	Internal
Audio Format	PCM
Color Depth	8bit
Color Space	YPbPr
HDCP	No
Active Signal	Yes
Vertical Resolution	3840
Horizontal Resolution	2168
Progressive / Interlaced	P
Refresh Rate	120Hz
Video Mode	DVI

ID	Name	Description
1	Output	Displays the current output information for HDMI and DVI modes.
2	Input	Displays the current input information for both audio and video.

Setup ▶ Output

1 Output Resolution 1400x1050@60Hz

2 Background Color Black Blue

4 Output Mode Selection Auto HDMI DVI

3 Output Color Space RGB 4:4:4 YCbCr 4:4:4 YCbCr 4:2:2

ID	Name	Description
1	Output Resolution	Click the drop-down list to select the output resolution.
2	Background Color	Sets the background color
3	Output Mode Selection (HDMI)	Click these buttons to set the desired HDMI output mode. The default setting is "Auto".
4	Output Color Space (HDMI)	Click these buttons to set the desired HDMI color space.

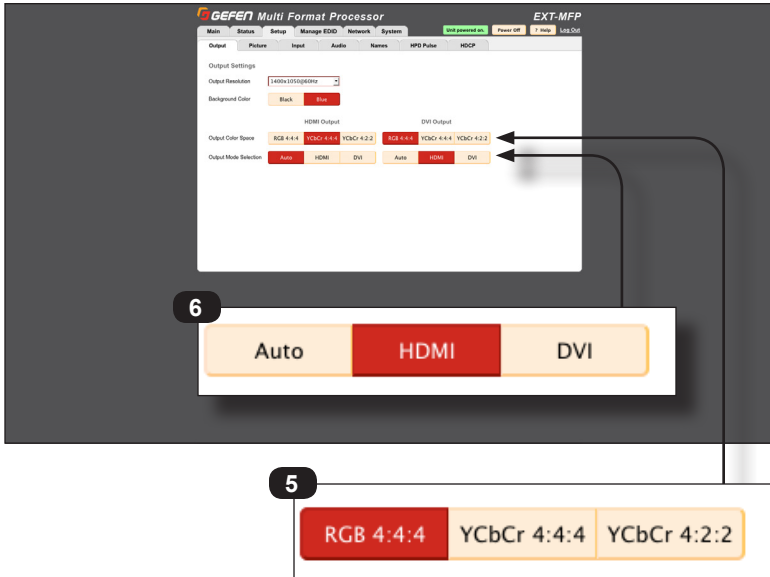

ID	Name	Description
5	Output Color Space (DVI)	Click these buttons to set the desired DVI color space.
6	Output Mode Selection (DVI)	Click these buttons to set the desired DVI output mode. The default setting is "HDMI".

Setup ► Picture

1

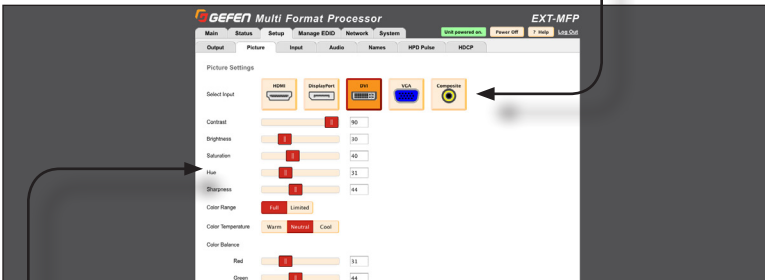

2

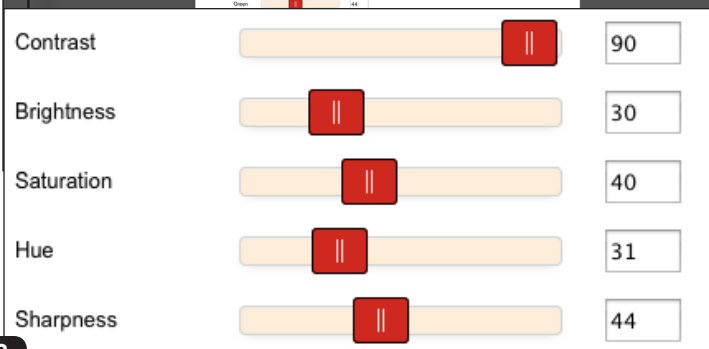

ID	Name	Description
1	Select Input	Click these buttons to select the desired input to be adjusted.
2	Contrast Brightness Saturation Hue Sharpness	Click and drag these slider controls to adjust the Contrast, Brightness, Saturation, Hue, and Sharpness of the picture.

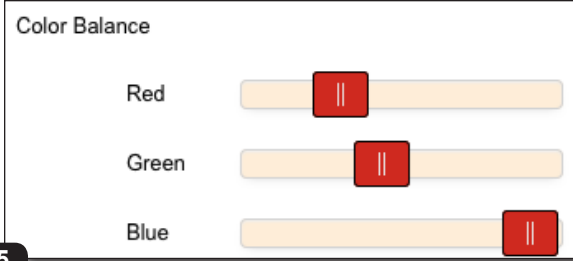

ID	Name	Description
3	Color Temperature	Click these buttons to set the desired Color Temperature. The default setting is "Neutral".
4	Output Mode Selection (DVI)	Click these buttons to set the desired Color Range. The default setting is "Full".
5	Color Balance	Click and drag these slider controls to adjust the Red, Green, and Blue Color Balance of the picture.

Setup ▶ Input

1

2

3

ID	Name	Description
1	Select Input	Click these buttons to select the desired input to be adjusted.
2	Overscan Underscan	Click these buttons to set the amount of overscan / underscan. Click the OFF button to disable overscan / underscan.
3	Aspect Ratio Control	Click these buttons to set the aspect ratio of the picture.

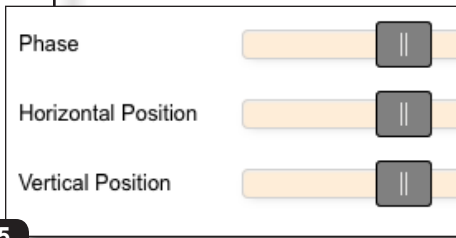
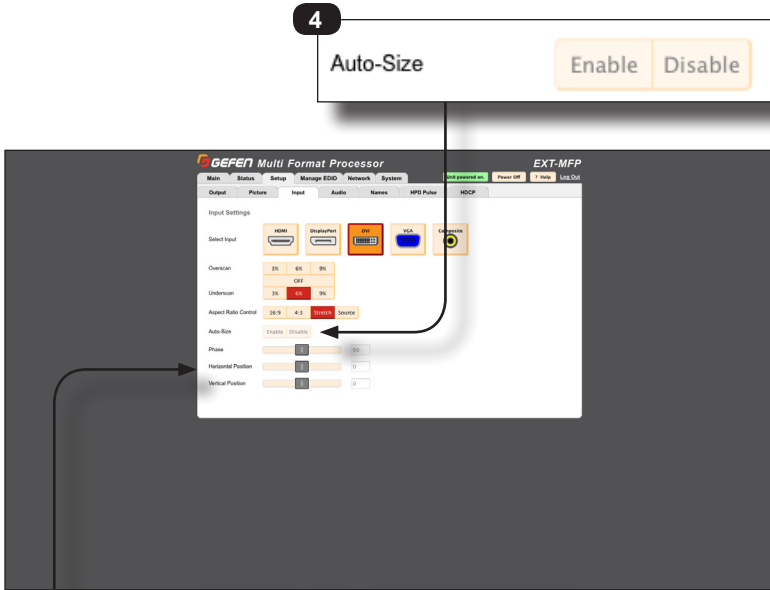

ID	Name	Description
4	Auto-Size	
5	Phase Horizontal Position Vertical Position	Click and drag these slider controls to adjust the Phase, Horizontal Position, and Vertical Position of the picture. These sliders are only available when using the VGA or Composite input.

Setup ▶ Audio

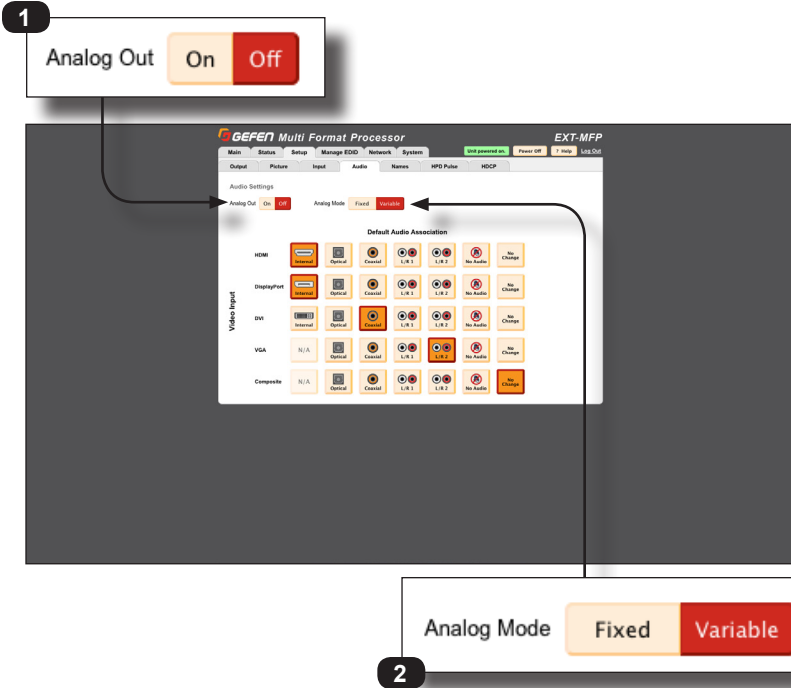

ID	Name	Description
1	Analog Out	Click these buttons to enable or disable analog audio output.
2	Analog Mode	Click these buttons to toggle between fixed or variable analog output. If set to "Fixed", then the Volume control (on the Main tab) is disabled. If set to "Variable", then the Multi-Format Processor controls the audio output level using the Volume control on the Main tab. See Main (page 81) for information on the Volume control.

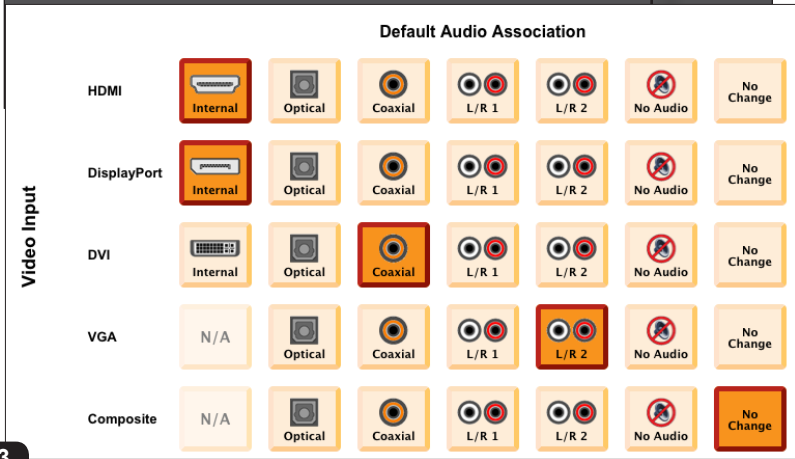

3

ID	Name	Description
3	Default Audio Association	<p>Click these buttons to set the audio association for each video input. For example, in the above screenshot, both the HDMI and DisplayPort video inputs are set to “Internal”. In addition, the DVI input is set to Coaxial, the VGA input is set to L/R 2, and the Composite input is set to “No Change”.</p> <p>Clicking No Audio will mute the audio on the selected video input. Clicking No Change will prevent the audio source from changing when switching video inputs. Refer to the next page for details on the “No Change” feature.</p>

As previously mentioned, the **No Change** button will prevent the audio source from changing when switching video inputs.

Example: Let say we have an DVI source using the Coaxial audio input. We want to switch to DisplayPort but use the audio from the Coaxial input. Here are the steps:

1. Under the **Setup > Audio** tab, we will set the **DisplayPort** audio input to **No Change**. This will prevent selecting of the **DisplayPort** input from changing the audio input.

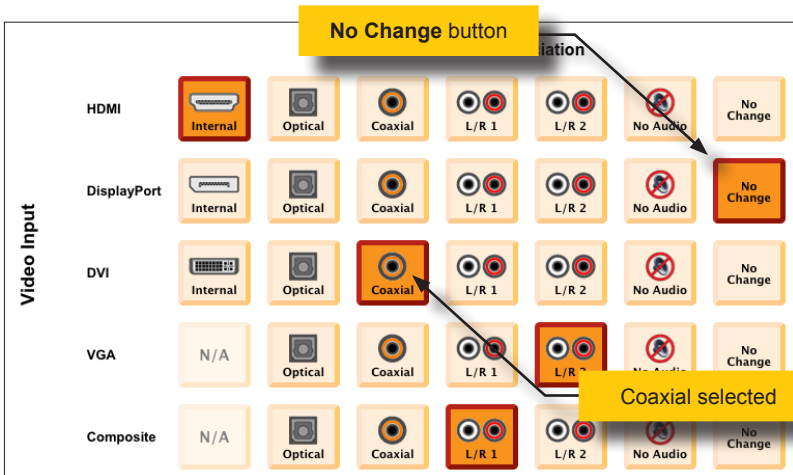

2. From the **Main** tab, the **DVI** input is using the **Coaxial** audio input. We can also see this association in the **Setup > Audio** tab, above.

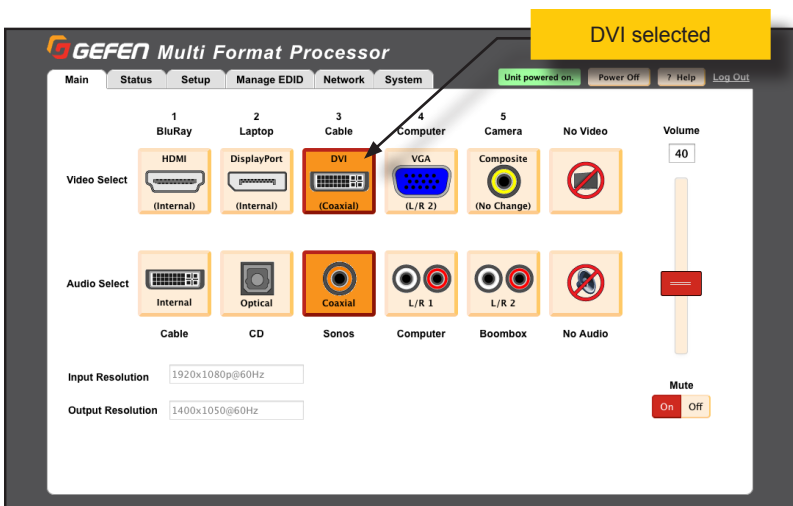

- Now, we'll switch to the **DisplayPort** video input.
- The **DisplayPort** video input is labeled as "(No Change)". This indicates that the audio source will not be changed when switching to this video input.

Also note that the Audio Select row shows a diagram of the DisplayPort interface and labels it as "Internal". This means that the digital audio channels embedded in the video signal are selected. Note that only the audio channels from the currently selected digital video source are available as the "Internal" selection.

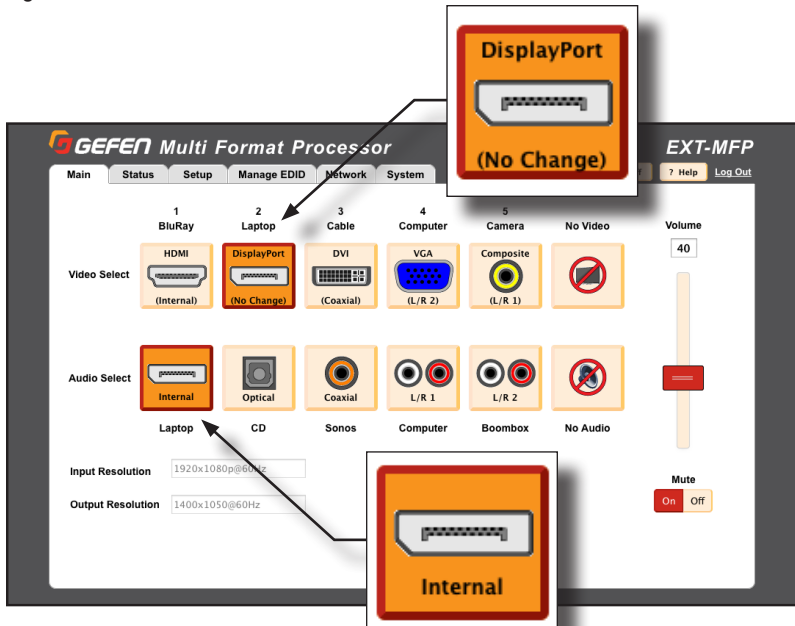

Information

If the audio selection is Internal and VGA or Composite Video are selected with "No Change" set, then there will be no audio output.

Setup ▶ Names

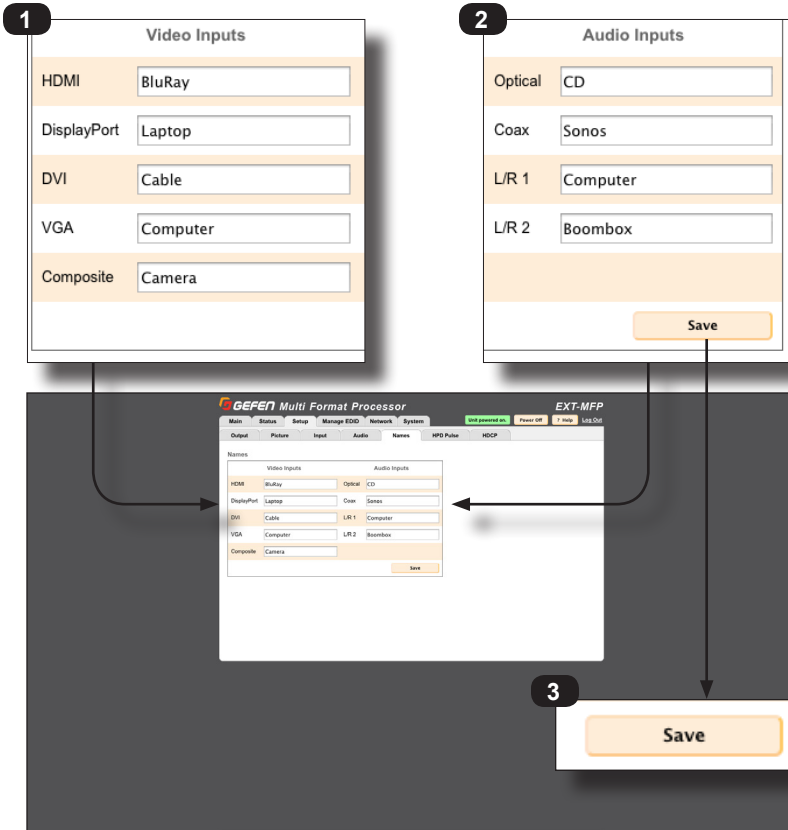

ID	Name	Description
1	Video Inputs	Click each of these boxes to activate them, then enter the desired name for each input. The name of the input cannot exceed 12 characters in length.
2	Audio Inputs	Click each of these boxes to activate them, then enter the desired name for each input. The name of the input cannot exceed 12 characters in length.
3	Save	Click this button to save all changes to the Video Inputs / Audio Inputs names.

Setup ► HPD Pulse

1

HPD Control

No.	Input	Name	
1	HDMI	BluRay	<input type="button" value="Pulse"/>
2	DisplayPort	Laptop	<input type="button" value="Pulse"/>
3	DVI	Cable	<input type="button" value="Pulse"/>



ID	Name	Description
1	HPD Control	Click the Pulse button to cycle the HPD line on the desired input. This is the equivalent of physically disconnecting and reconnecting the HDMI / DisplayPort / DVI cable between the source device and the Multi-Format Processor.

Setup ► HDCP

1

HDCP Handshake

No.	Input	Name		
1	HDMI	BluRay	Accepted	Reject
2	DisplayPort	Laptop	Accept	Rejected
3	DVI	Cable	Accepted	Reject
All Inputs			Accept	Reject

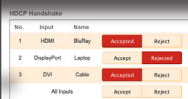

No.	Input	Name		
1	HDMI	BluRay	Accepted	Reject
2	DisplayPort	Laptop	Accept	Rejected
3	DVI	Cable	Accepted	Reject
All Inputs			Accept	Reject

ID	Name	Description
1	HDCP Handshake	<p>Controls whether the source transmits HDCP content to the Multi-Format Processor. Click the Accepted button to allow the source to transmit HDCP. Click the Rejected button to prevent HDCP content from being transmitted.</p> <p>To allow all sources to transmit HDCP, click the Accept button, in the row labeled "All Inputs". To prevent all sources from transmitting HDCP content, click the Do Not Accept button</p>

Manage EDID ▶ EDID Mode

1

EDID Mode

Input	Input Name	EDID Mode
1 - HDMI	BluRay	Internal - 720p 2 ch audio
2 - DisplayPort	Laptop	External - DVI Output
3 - DVI	Cable	Internal - 1080p 2 ch audio
4 - VGA	Computer	Internal - 720p 2 ch audio



Input	Input Name	EDID Mode	EDID Name
1 - HDMI	BluRay	Internal - 720p 2 ch audio	Sony FP
2 - DisplayPort	Laptop	External - DVI Output	Panasonic
3 - DVI	Cable	Internal - 1080p 2 ch audio	Vizio
4 - VGA	Computer	Internal - 720p 2 ch audio	Benq

ID	Name	Description
1	EDID Mode	<p>Select the EDID mode from the drop-down list for each input:</p> <ul style="list-style-type: none"> Internal - 720p 2 ch audio Internal - 720p Multi ch Internal - 1080p 2 ch audio Internal - 1080p Multi ch External - HDMI Output External - DVI Output Custom - User-defined

(continued on next page)

Manage EDID ▶ EDID Copy

1

Select EDID to Copy

Select One

Outputs

HDMI

DVI

Inputs

BluRay

Laptop

Cable

Computer

HDMI

DisplayPort

DVI

VGA

Storage Location

Bank 1

Bank 2

Bank 3

Bank 4

Bank 5

Bank 6

Bank 7

Bank 8

EDID 1

EDID 2

EDID 3

EDID 4

EDID 5

EDID 6

EDID 7

EDID 8

Select EDID to Copy

Select One

Outputs

HDMI

DVI

Inputs

BluRay

Laptop

Cable

Computer

HDMI

DisplayPort

DVI

VGA

Storage Location

Bank 1

Bank 2

Bank 3

Bank 4

Bank 5

Bank 6

Bank 7

Bank 8

EDID 1

EDID 2

EDID 3

EDID 4

EDID 5

EDID 6

EDID 7

EDID 8

Select Copy Destination

Select One or More

Inputs

Inputs must be in custom EDID mode

BluRay

Laptop

Cable

Computer

HDMI

DisplayPort

DVI

VGA

Storage Location

Bank 1

Bank 2

Bank 3

Bank 4

Bank 5

Bank 6

Bank 7

Bank 8

EDID 1

EDID 2

EDID 3

EDID 4

EDID 5

EDID 6

EDID 7

EDID 8

Copy

2

Select Copy Destination

Select One or More

Inputs

Inputs must be in custom EDID mode

BluRay

Laptop

Cable

Computer

HDMI

DisplayPort

DVI

VGA

Storage Location

Bank 1

Bank 2

Bank 3

Bank 4

Bank 5

Bank 6

Bank 7

Bank 8

EDID 1

EDID 2

EDID 3

EDID 4

EDID 5

EDID 6

EDID 7

EDID 8

Copy

3

ID	Name	Description
1	Select EDID to Copy	Click on the device you want to copy the EDID from. This can be an Output (Display), an EDID saved at an Input location, or one of the Storage Locations.
2	Select Copy Destination	Select the Destination for the copied EDID. This can be an Input (in "Custom EDID" Mode only) or a Storage Location.
3	Copy	Click this button to actually copy the EDID file to the selected location(s).

Manage EDID ► EDID Info

The screenshot shows the GEFEEN Multi Format Processor web interface. The 'Manage EDID' tab is active, and the 'EDID Info' sub-tab is selected. A dropdown menu labeled 'Choose EDID' is set to 'HDMI - BluRay'. Below it, a list of EDID banks is shown, with 'HDMI - BluRay' selected. The 'Feature' section displays the following video specifications:

Feature	Value
24Hz Frame Rate	FALSE
Max Resolution	1920x1080 60Hz
Max Color Depth	NONE
Mode (DVI/HDMI)	HDMI
Max Audio Channels	8-Ch
Monitor Name	YES

The 'Audio Formats' section displays the following supported audio formats:

Audio Format	Value
LPCM	DTR-40.4
DTS-HD	YES
DTS Digital Surround	YES
Dolby Digital (AC3)	YES
Dolby TrueHD	YES

This page shows the EDID information that is contained in each of the EDID Banks, and stored for each Video Input that supports EDID.

ID	Name	Description
1	Choose EDID	Choose the EDID file to display the EDID information for that device
2	Feature	Shows the video specification supported by that EDID
	Audio Formats	Shows the audio specifications supported by that EDID

Manage EDID ► Edit Bank Names

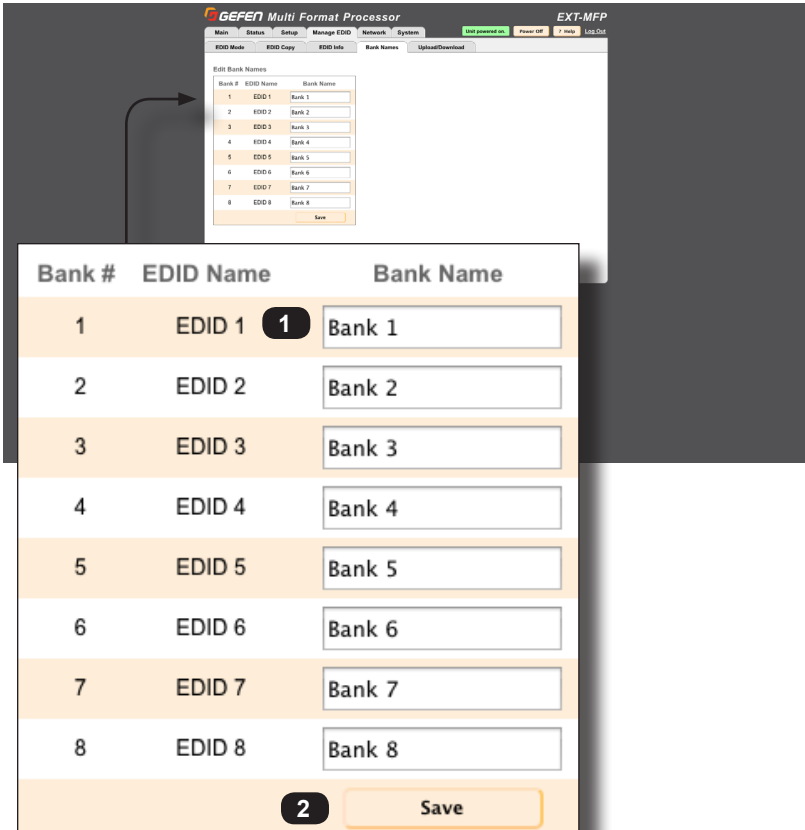

This page allows you to re-name the internal EDID bank names to make them easier to remember.

ID	Name	Description
1	Edit EDID name	Edit the EDID Name
	Save	Save the new EDID name.

Manage EDID ► Upload/Download

Upload EDID to the EXT-MFP

Select EDID File:

Browse...

1

Select Destination:

Bank 1

2

Upload

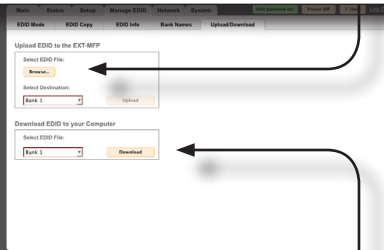

Download EDID to your Computer

Select EDID File:

Bank 1

3

Download

This page lets you either upload an existing EDID file on your computer to a Bank or location in the Multi-Format Processor, or download an EDID file from the Multi-Format Processor to a location on your computer (EDID files are in *.bin binary format).

ID	Name	Description
1	Select EDID File	Browse your computer for an appropriate EDID file.
2	Select Destination	Select a Bank location for the downloaded file.
	Select EDID File	Select an EDID file location (Bank, Input or Output) in the Multi-Format Processor to download to your computer.

Network ► IP Settings

The screenshot shows the 'IP Settings' configuration page. The MAC Address is 00:1c:91:04:50:d6, the HTTP Port is 80, and the Mode is set to Static. The IP Address is 10.5.64.93, the Subnet is 255.255.255.0, and the Gateway is 10.5.64.1. The TCP/Net Settings section is also visible, showing TCP Access set to Enable, Telnet Port set to 23, and Login Message on Connect set to Show.

ID	Name	Description
1	IP Settings	<p>Allows setting of DHCP or Manual IP Address, Subnet, and Gateway (Router) addresses and HTTP Port (Default IP Address is 192 . 168 . 1 . 72).</p> <p>The IP Address, Subnet, and Gateway fields are enabled if the Mode is set to Static.</p>

Network ► TCP/Telnet Settings

GEFEN Multi Format Processor EXT-MFP

Main Status Setup Manage EDD Network System Setup powered on Power Off 1.7.1000 102.104

IP Settings

MAC Address 00:14:10:40:00:00 IP Address 18.8.64.93

HTTP Port 80 Subnet 255.255.255.0

Mode None DiscP Gateway 18.8.64.1

TCP/Telnet Settings

TCP Access Enabled Disable User Name Admin

Telnet Port 23 Old Password

Login Message on Connect Show Hide New Password

Require Password on Connect Enabled Disable Confirm New Password

UDP Settings

UDP Access Enabled Disable Remote UDP IP Address 192.168.1.255

UDP Port 10007 Remote UDP Port 10008

Remote UDP Access Enabled Disable

TCP/Telnet Settings

TCP Access

Enabled Disable

Telnet Port

23

Login Message on Connect

Show Hide

Require Password on Connect

Enabled Disable

2

User Name

Admin

Old Password

New Password

Confirm New Password

ID	Name	Description
2	TCP/Telnet Settings	<p>Allows settings for TCP Access and Telnet Control (Remote Control over IP). This is for connection to Crestron or other control systems.</p> <p>The Old Password, New Password, and Confirm New Password fields are only enabled if the Require Password on Connect option is set to Enabled.</p>

Network ► UDP Settings

GEFEN Multi Format Processor EXT-MFP

Main Status Setup Manage EDD Network System Get power on Power off RT Menu Log Out

IP Settings

MAC Address 00:1c:1d:04:00:08 P Address 192.168.4.93

HTTP Port 80 Subnet 255.255.255.0

Mode Static DHCP Gateway 192.168.1

TCP/Telnet Settings

TCP Access Enabled Disable User Name Admin

Telnet Port 23 Old Password

Login Message on Connect Show Hide New Password

Require Password on Connect Enabled Disable Confirm New Password

UDP Settings

UDP Access Enabled Disable Remote UDP IP Address 192.168.1.255

UDP Port 50007 Remote UDP Port 50008

Remote UDP Access Enabled Disable

Web Login Settings

Username Operator Administrator Old Password

New Password Confirm New Password

UDP Settings

UDP Access

Enabled

Disable

UDP Port

50007

Remote UDP Access

Enabled

Disable

3

Remote UDP IP Address 192.168.1.255

Remote UDP Port 50008

ID	Name	Description
3	UDP Settings	<p>Allows enabling and settings for UDP control. UDP offers faster communications, but lacks guaranteed delivery. It is supported by some control systems.</p> <p>The Remote UDP IP Address and Remote UDP Port fields are only enabled if the Remote UDP Access option is set to Enabled.</p>

Network ► Web Login Settings

The screenshot shows the 'Network' configuration page for a GEFEN Multi Format Processor. The 'Web Login Settings' section is highlighted with a red box and an arrow pointing to a callout box. The settings include:

- IP Settings:** MAC Address (08:1c1d:04:00:08), IP Address (192.168.1.135), HTTP Port (80), Subnet (255.255.255.0), Mode (Static), and Gateway (192.168.1.1).
- TCP/Telnet Settings:** TCP Access (Enabled/Disabled), Telnet Port (23), Log Message on Connect (Show/Hide), and Require Password on Connect (Enabled/Disabled).
- UDP Settings:** UDP Access (Enabled/Disabled), UDP Port (10007), Remote UDP IP Address (192.168.1.255), and Remote UDP Port (10008).
- Web Login Settings:** Username (Operator/Administrator), Old Password, New Password, and Confirm New Password.
- Discovery Protocol Settings:** Enable Discovery (Enabled/Disabled), Find Your Device (Show/Hide), Discover Read Only (Read Only/Read/Write), and Product Description (EXT-MFP).

Web Login Settings

Username

Operator Administrator

New Password

4

Old Password

Confirm New Password

ID	Name	Description
4	Web Login Settings	Allows setting and changing of Operator and Administrator passwords. The default password for Administrator is Admin. The default password for Operator is Operator. Passwords are <i>case-sensitive</i> .

Network ► Discovery Protocol Settings

The screenshot shows the 'Network' configuration page for the 'EXT-MFP' device. The 'Discovery Protocol Settings' section is highlighted with a callout box. It contains two main settings:

- Enable Discovery:** A toggle switch currently set to 'Enabled' (indicated by a red button). A callout box with the number '5' points to this button.
- Find Your Device:** A button labeled 'Show Me' (indicated by a callout box with the number '6').

Discovery Protocol Settings

Enable Discovery

5

Enabled

Disable

Find Your Device

6

Show Me

ID	Name	Description
5	Enable Discovery	When set to Enabled, the Multi-Format Processor can be detected using the Gefen Syner-G Software Suite or Syner-G App.
6	Find Your Device	Click the Show Me button to locate the Multi-Format Processor on the network. When this button is clicked, the button text will change to “Hide Me” and all LED indicators on the front panel will flash. Click the “Hide Me” button to stop the LED indicators from flashing.

(continued on next page)

The screenshot shows the 'Network' configuration page for the GEFER Multi Format Processor. The 'Discovery Protocol Settings' section contains a dropdown menu for 'Discover Read Only' with three options: 'Discover Read Only', 'Read Only', and 'Read/Write'. The 'Product Description' field is populated with 'EXT-MFP'. At the bottom of the page, there are two buttons: 'Set Network Defaults' and 'Save'. A callout box provides a legend for these elements: 'Discover Read Only' is labeled with a circled '7', 'Read Only' is labeled with a circled '8', 'Read/Write' is labeled with a circled '9', 'Set Network Defaults' is labeled with a circled '9', and 'Save' is labeled with a circled '10'.

ID	Name	Description
7	Discover Read Only	When set to Read Only , the IP settings for the Multi-Format Processor will be displayed by Syner-G but they cannot be changed. In order to display and change IP settings, this option must be set to Read/Write .
8	Product Description	EXT-MFP is the default product description of the Multi-Format Processor. This name will be used to identify the Multi-Format Processor within the Syner-G software.
9	Set Network Defaults	Click this button to reset the Multi-Format Processor to factory-default settings.
10	Save	Click this button to save all changes within the Network tab.

System

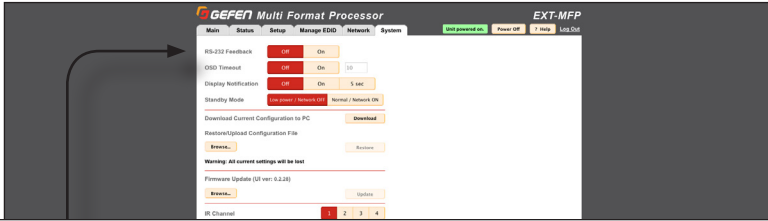

1	RS-232 Feedback	Off	On	
2	OSD Timeout	Off	On	10
3	Display Notification	Off	On	5 sec
4	Standby Mode	Low power / Network OFF	Normal / Network ON	

ID	Name	Description
1	RS-232 Feedback	Turns off RS-232 feedback for compatibility with one-way control systems.
2	OSD Timeout	Sets the timeout for the On-Screen Display.
3	Display Notification	Displays the current source in the upper-left corner of the display whenever it is changed.
4	Standby Mode	Turns off IP Control. This meets EnergyStar requirements, but does not allow unit to be turned back on over IP. Only choose the Low power / Network OFF option if you are NOT using IP control.

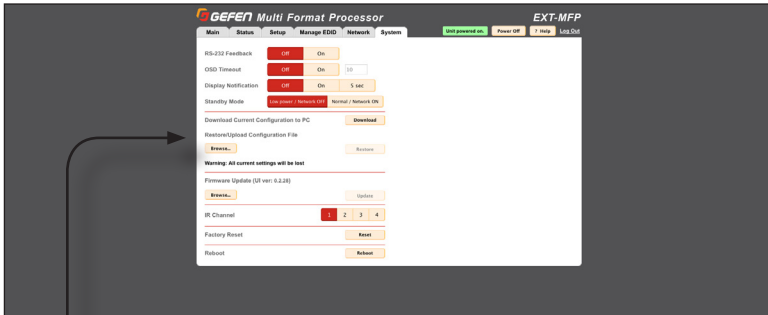

5 Download Current Configuration to PC

Download

6 Restore/Upload Configuration File

Browse...

Restore

Warning: All current settings will be lost

ID	Name	Description
5	Download Current Configuration to PC	<p>Click the Download button to download the entire Multi-Format Processor configuration to an .XML file on your computer. The default filename is <code>settings.gfn</code>.</p> <p>If you wish to save multiple configuration files, be sure to rename the last file that was downloaded so that it does not get overwritten.</p> <p>The XML file can be restored to the unit, or copied to other units to “clone” the Multi-Format Processor configuration.</p>
6	Restore / Upload Configuration File	<p>Click the Browse... button to select the configuration file (.xml format) to be uploaded to the Multi-Format Processor. Click the Restore button to begin the upload process.</p>

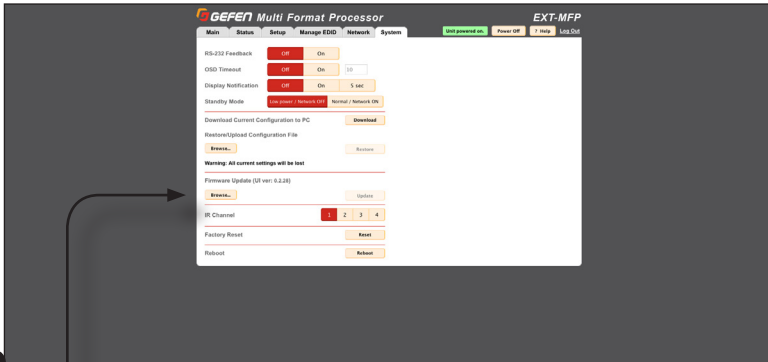

7

Firmware Update (UI ver: 0.2.28)

Browse...

Update

ID	Name	Description
7	Firmware Update	<p>Firmware Updates can be found at www.gefen.com, or through the Gefen Syner-G Tool. Download the update to your PC, then click the Browse... button to select the firmware file. Click the Update button to begin the update process.</p> <p>The current version of firmware that the Multi-Format Processor is running is displayed above the Browse... button.</p>

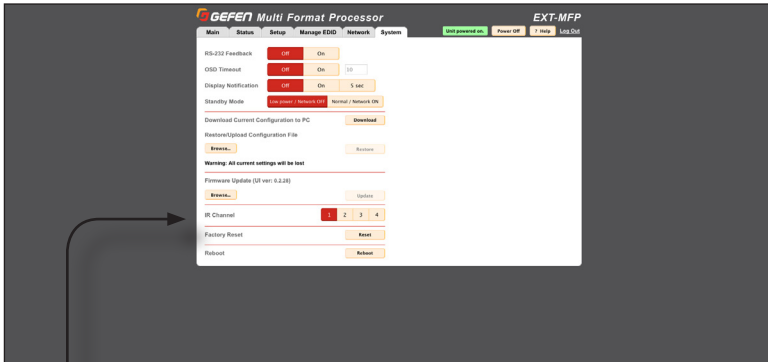

8 IR Channel

1

2

3

4

9 Factory Reset

Reset

10 Reboot

Reboot

ID	Name	Description
8	IR Channel	Click the desired button (1 - 4) to change the IR channel used by the included IR remote control unit. The IR channel should only be changed if the current channel is conflicting with another IR remote control that is using the same channel. See page Setting the IR Channel (page 8) for instructions on how to change the IR channel of the IR remote control unit.
9	Factory Reset	Reset the Multi-Format Processor to factory-default settings. If the unit has been configured, be sure to download the configuration file <i>before</i> resetting it. If your configuration gets corrupted, it can often be fixed by downloading the configuration file, resetting the unit to factory-default settings, then re-uploading the configuration file.
10	Reboot	Click the Reboot button to reboot the Multi-Format Processor. This is the same as power-cycling the unit.

Multi-Format Processor

3

Advanced Operation

RS-232 Interface

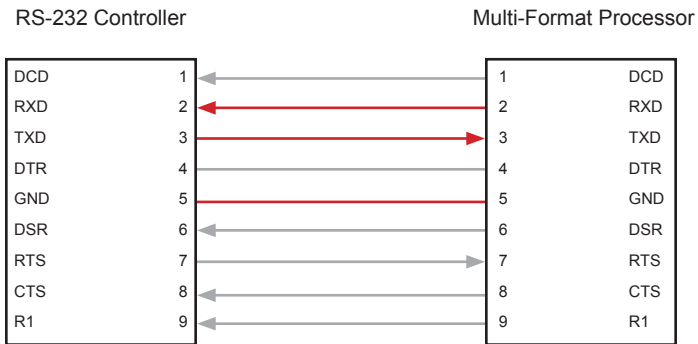
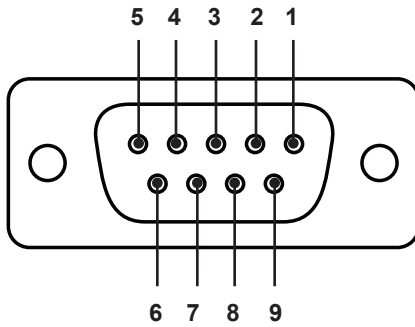

Only TXD, RXD, and GND pins are used.

RS-232 Settings

Description	Setting
Baud rate	19200
Data bits	8
Parity	None
Stop bits	1
Hardware flow control	None

The Multi-Format Processor supports IP-based control using Telnet, UDP, or the built-in Web-based GUI. To set up IP control, the network settings may need to be configured. The default network settings for the Multi-Format Processor are as follows:

Description	IP Address / Port	Description	IP Address / Port
IP Address	192.168.1.72	Telnet Port	23
Subnet	255.255.255.0	Local UDP Port	50007
Gateway	192.168.1.254	Remote UDP IP	192.168.1.129
HTTP Port	80	Remote UDP Port	50008

All IP settings can be easily changed using the **Gefen Syner-G Software Suite** or the **Syner-G Discovery Tool** App for iOS and Android. See [Syner-G Discovery Tool \(page 77\)](#) for more information.

Alternatively, the configuration settings can be assigned using RS-232 commands, using the process below.

1. Launch a terminal emulation program (e.g. HyperTerminal) and use the RS-232 settings listed on the previous page.
2. Set the IP address using the `#set_ipadd` command.



Information

Depending upon the network, all related IP, Telnet, and UDP settings will need to be assigned. Consult your network administrator to obtain the proper settings.

3. Set the subnet mask using the `#set_netmask` command.
4. Set the gateway (router) IP address using the `#set_gateway` command.
5. Set the Telnet listening port using the `#set_telnet_port` command.
6. Set the HTTP listening port using the `#set_http_port` command.
7. Set the UDP remote IP address for the using the `#set_udp_remote_ip` command.
8. Set the UDP listening port using the `#set_udp_port` command.
9. Set the UDP remote port using the `#set_udp_remote_port` command.
10. Reboot the processor to apply all changes, then type the IP address that was specified in step 3, in a Web browser to access the Web GUI. Use the same IP address to Telnet to the Multi-Format Processor.

Command	Description
Power	
#power	Power The Unit On/Off
#get_power	Get Current Power State
#set_low_power	Set low power standby mode
Special	
#get_mac_addr	Displays the MAC address
#help	Displays the list of available commands.
Routing	
#set_input	Set Input Source with Associated Audio Source
#get_input	Get Input Source
#set_audio_input	Set Audio Source
#get_audio_input	Get Audio Source
Output	
#set_output_res	Set output resolution
#get_output_res	Get the current output resolution
#set_output_color	Set output color space per display
#get_output_color	Get output color space per display
#set_output_mode	Set output mode per display
#get_output_mode	Get output mode per display
#set_background_color	Set background color
#get_background_color	Get background color
Input	
#get_input_res	Get The Current Input Resolution
#set_video_name	Set The Video Input Name
#get_video_name	Get The Video Input Name
#set_audio_name	Set The Audio Input Name
#get_audio_name	Get The Audio Input Name

Command	Description
Picture	
#set_contrast	Set picture contrast
#get_contrast	Get picture contrast
#set_brightness	Set picture brightness
#get_brightness	Get picture brightness
#set_saturation	Set picture saturation
#get_saturation	Get picture saturation
#set_hue	Set picture hue
#get_hue	Get picture hue
#set_color_range	Sets output color range
#get_color_range	Gets output color range
#set_color_temp	Set picture color temperature
#get_color_temp	Get picture color temperature
#set_color_balance	Set picture color balance
#get_color_balance	Get picture color balance
#set_sharpness	Set picture sharpness
#get_sharpness	Get picture sharpness
Adjust	
#set_input_hdcp	Set Input HDCP compatibility on or off
#get_input_hdcp	Get Input HDCP compatibility on or off
#set_uo_scan	Set under/over scan
#get_uo_scan	Get under/over scan
#send_hpd	Send HPD (Hot Plug Detect) Pulse
#set_auto_size	Set VGA input auto size adjust
#set_phase	Set VGA input phase
#get_phase	Get VGA input phase
#set_h_position	Set VGA horizontal input position
#get_h_position	Get VGA horizontal input position
#set_v_position	Set VGA vertical input position
#get_v_position	Get VGA vertical input position
#set_aspect_ratio	Set aspect ratio
#get_aspect_ratio	Get aspect ratio

Command	Description
Audio	
#set_mute	MUTE/UNMUTE both analog and HDMI outputs
#get_mute	Get MUTE/UNMUTE status
#set_analog_vol	Set analog analog output volume
#get_analog_vol	Get analog analog output volume
#set_analog_out	Set analog output on or off
#get_analog_out	Get status of analog output
#set_analog_mode	Set analog analog output mode
#get_analog_mode	Get analog analog output mode
#set_audio_link	Set associated audio source for selected input
#get_audio_link	Get associated audio source for selected input
EDID	
#set_edid	Set Bank/Output EDID To Input / Bank
#set_bank_name	Set The EDID Bank Name
#get_bank_name	Set The EDID Bank Name
Network	
#set_ipmode	Set Ip Mode To DHCP Or Manual
#get_ipmode	Get Current IP Mode
#get_ipconfig	Get Ip Configuration
#set_ipadd	Set Ip Address
#get_ipadd	Print The Ip Address To The Screen
#set_netmask	Set Subnet Address
#get_netmask	Print The Netmask Address To The Screen
#set_gateway	Set Gateway Address
#get_gateway	Print The Gateway Address To The Screen
#set_http_port	Set The HTTP Communication Port
#get_http_port	Print The HTTP Communication Port To The Screen
#set_telnet_enable	Enable Or Disable Telnet Access
#get_telnet_enable	Print The Telnet Access Status To The Screen
#set_telnet_port	Set The Telnet Communication Port
#get_telnet_port	Print The Telnet Communication Port To The Screen
#set_use_telnet_pass	Enable Or Disable The Telnet Password
#get_use_telnet_pass	Get Status Of Use Telnet Password
#set_telnet_welcome	Enable Or Disable The Telnet Welcome Screen
#get_telnet_welcome	Get Status Of The Telnet Welcome Screen
#set_udp_port	Set The UDP Communication Port

Command	Description
#get_udp_port	Get The UDP Communication Port
#set_remote_udp_enable	Enable Or Disable The Remote UDP Access
#get_remote_udp_enable	Get Status Of Remote UDP Access
#set_udp_remote_ip	Set The Remote UDP Ip Address
#get_udp_remote_ip	Get The Remote UDP Ip Address
#set_udp_remote_port	Set The Remote UDP Communication Port
#get_udp_remote_port	Get The Remote UDP Communication Port
#set_udp_enable	Enable Or Disable The UDP Access
#get_udp_enable	Get Status Of The UDP Access
#set_webui_ad_pass	Set The Web UI Administrator Password
#set_webui_op_pass	Set The Web UI Operator Password
Discovery	
#set_discovery	Enable/Disable Discovery Service
#get_discovery	Get Status Of Discovery Service
#set_showme	Turn The Discovery 'Show Me' Feature On / Off
#set_discovery_mode	Set The Discovery Read/Write Mode
#get_discovery_mode	Get The Discovery Read/Write Mode
#set_device_descr	Set The Device Description
#get_device_desc	Get The Device Description
System	
#set_osd_timeout	Set OSD Timeout
#get_osd_timeout	Get OSD Timeout
#set_display_notify	Set Display Notifications
#get_display_notify	Get Display Notifications
#set_feedback	Turn (Unsolicited) RS-232 Feedback On Or Off
#get_feedback	Get Status Of RS-232 Feedback On Or Off
#get_firmware_version	Get Firmware Version
#set_ir_channel	Set IR Command Channel
#get_ir_channel	Get IR Command Channel
#factory_reset	Reset To Factory Defaults
#reboot	Reboot The Unit

#power

Powers the Multi-Format Processor On and Off. All settings will be preserved when power is lost or cycled. Unit should recover to same state before power loss/cycle event.

Syntax

```
#power param1
```

Parameters

param1 Integer [0 ... 1]

param1	Description
0	Standby
1	On

Example

```
#power 1  
POWER IS ON
```

Related Commands

```
#get_power  
#set_low_power
```

#get_power

Displays the current power state.

Syntax

```
#get_power
```

Parameters

none

Example

```
#get_power  
POWER IS ON  
POWER IS OFF
```

Related Commands

```
#power
```

#set_low_power

If the Multi-Format Processor will be controlled via the Web interface or via IP commands, then *param1* must be set to 1. This setting turns off the Ethernet port is turned off when the Multi-Format Processor is placed in *standby mode* (Power LED indicator on front panel is red) in order to reduce power consumption. Turning off the Ethernet port will reduce power consumption to under 0.5W but will not allow the Multi-Format Processor to be turned on using IP control or the Web interface.

0 - RS-232/IR / Front Panel Only (Power Consumption < 0.5W)

1 - IP Control / RS-232 / IR / Front Panel (Power Consumption > 0.5W)

Syntax

```
#set_low_power param1
```

Parameters

param1 Integer [0 ... 1]

param1	Description
0	Off
1	On

Examples

```
#set_low_power 1
LOW POWER STANDBY IP IS SET TO ON
```

```
#set_low_power 0
LOW POWER STANDBY IP IS SET TO OFF
```

Related Commands

```
#get_power
```

#get_mac_addr

Displays the MAC address of the Multi-Format Processor.

Syntax

```
#get_mac_address
```

Parameters

none

Example

```
#get_mac_addr  
MAC ADDRESS IS 00:1c:91:04:50:13
```

#help

Displays the list of available commands. If a command is specified with *param1*, then the description of the command is displayed.

Syntax

```
#help (param1)
```

Parameters

param1

Command (optional)

param1	Description
[none]	Print All Commands
#set_input	Print #set_input Command

Examples

```
#help
```

```
AVAILABLE COMMANDS
```

```
-----
```

```
#POWER
```

```
#GET_POWER
```

```
#SET_LOW_POWER
```

```
#GET_MAC_ADDR
```

```
.
```

```
.
```

```
.
```

```
#FACTORY_RESET
```

```
#REBOOT
```

```
-----
```

```
#help #set input
```

```
SET INPUT SOURCE WITH ASSOCIATED AUDIO SOURCE
```

```
#SET_INPUT PARAM1
```

```
PARAM1 =
```

```
HDMI
```

```
DP
```

```
DVI
```

```
VGA
```

```
COMP
```

```
NOVIDEO
```

#set_input

Sets the input video source. The default setting is HDMI.

Syntax

```
#set_input param1
```

Parameters

param1

String

param1	Description
HDMI	HDMI Input (1)
DP	DisplayPort Input (2)
DVI	DVI Input (3)
VGA	VGA Input (4)
COMP	Composite Video Input (5)
NOVIDEO	Video Off

Example

```
#set_input hdmi  
INPUT SET TO HDMI
```

Related Commands

```
#set_audio_input
```

Default

HDMI

#get_input

Displays the currently selected video input.

Syntax

```
#get_input
```

Parameters

none

Example

```
#get_input  
INPUT SET TO HDMI
```

Related Commands

```
#set_input
```

#set_audio_input

Sets the input audio source. The default setting is *int*.

Syntax

```
#set_audio_input param1
```

Parameters

param1

Input

param1	Description
INT	Internal (Embedded) Digital Audio Input (HDMI, DVI, or DisplayPort)
OPT	Optical Input
COAX	Coaxial Input
LR1	Analog Stereo Input 1
LR2	Analog Stereo Input 2
NOAUDIO	Audio Off

Example

```
#set_audio_input lr1  
AUDIO INPUT SET TO LR1
```

Related Commands

```
#get_audio_input
```

#get_audio_input

Displays the currently selected audio input.

Syntax

```
#get_audio_input
```

Parameters

none

Example

```
#get_audio_input  
AUDIO INPUT SET TO LR1
```

Related Commands

```
#set_audio_input
```

#set_output_res

Sets the output video resolution. The default setting is HD (1080p) Auto Refresh.

Syntax

```
#set_output_res param1
```

Parameters

param1 Integer [0 ... 26]

param1	Description	param1	Description
0	Auto-Detect	14	SD (480i) 60Hz
1	640x480 60Hz	15	SD (576i) 50Hz
2	800x600 60Hz	16	SD (480p) 60Hz
3	1024x768 60Hz	17	SD (576p) 50Hz
4	1280x768 60Hz	18	HD (720p) 60Hz
5	1280x800 60Hz	19	HD (720p) 50Hz
6	1280x1024 60Hz	20	HD (1080i) 60Hz
7	1360x768 60Hz	21	HD (1080i) 50Hz
8	1366x768 60Hz	22	HD (1080p) 60Hz
9	1440x900 60Hz	23	HD (1080p) 50Hz
10	1400x1050 60Hz	24	HD (1080p) 25Hz
11	1600x900 60Hz	25	HD (1080p) 24Hz
12	1680x1050 60Hz	26	HD (1080p) Auto Refresh
13	1920x1200 60Hz		

Example

```
#set_output_res 18
OUTPUT_RESOLUTION SET TO HD (720p) 60Hz
```

#get_output_res

Displays the current video output resolution.

Syntax

```
#get_output_res
```

Parameters

None

Example

```
#get_output_res  
OUTPUT RESOLUTION IS HD (1080p) Auto Refresh
```

Related Commands

```
#set_output_res
```

#set_output_color

Sets the output color space for the specified display. The default settings for both Output 1 (HDMI) and Output 2 (DVI) are RGB 4:4:4.

Syntax

```
#set_output_color param1 param2
```

Parameters

param1 Video Output

param1	Description
1	Output 1 (HDMI Connector)
2	Output 2 (DVI Connector)

param2 Color Space

param2	Description
0	RGB 4:4:4
1	YCbCr 4:4:4
2	YCbCr 4:2:2

Example

```
#set_output_color 1 1
OUTPUT COLOR SPACE OF OUTPUT 1 SET TO YCBCR 444
```

Related Commands

```
#set_output_mode
#get_output_color
```

#get_output_color

Displays the video output color space for the specified display.

Syntax

```
#get_output_color param1
```

Parameters

param1 Integer [1 ... 2]

param1	Description
1	Output 1 (HDMI Connector)
2	Output 2 (DVI Connector)

Example

```
#get_output_color 2  
OUTPUT COLOR SPACE OF OUTPUT 2 SET TO RGB 444
```

Related Commands

```
#get_output_mode
```

#set_output_mode

Sets the output mode for the specified display. The default settings for both Output 1 (HDMI) and Output 2 (DVI) are Auto.

Syntax

```
#set_output_mode param1 param2
```

Parameters

param1 Integer [1 ... 2]

param1	Description
1	Output 1 (HDMI Connector)
2	Output 2 (DVI Connector)

param2 String

param2	Description
hdmi	HDMI
dvi	DVI
auto	Auto

Example

```
#set_output_mode 1 hdmi
OUTPUT MODE OF OUTPUT 1 SET TO HDMI
```

Related Commands

```
#set_output_color
```

#get_output_mode

Displays the video output mode of the specified display.

Syntax

```
#get_output_mode param1
```

Parameters

param1 Integer [1 ... 2]

param1	Description
1	Output 1 (HDMI Connector)
2	Output 2 (DVI Connector)

Example

```
#get_output_mode 1  
OUTPUT MODE OF OUTPUT 1 SET TO HDMI
```

Related Commands

```
#get_output_mode
```

#set_background_color

Sets the background color. The background color is seen when there is no video source present. The default color is blue.

Syntax

```
#set_background_color param1
```

Parameters

param1 Integer [0 ... 1]

param1	Description
0	Blue
1	Black

Example

```
#set_background_color 1  
BACKGROUND COLOR SET TO BLACK
```

Related Commands

```
#get_background_color
```

#get_background_color

Displays the current background color setting.

Syntax

```
#get_background_color
```

Parameters

None

Example

```
#get_background_color  
BACKGROUND COLOR SET TO BLACK
```

Related Commands

```
#set_background_color
```

#get_input_res

Displays the input resolution of the currently selected source.

Syntax

```
#get_input_res
```

Parameters

None

Example

```
#get_input_res  
INPUT RESOLUTION SET TO 1280x720p60 YCBCR 422
```

Related Commands

```
#set_output_res
```

#set_video_name

Sets the Web GUI name for the specified video input. The value of *param2* cannot exceed 12 characters in length and cannot contain spaces.

Syntax

```
#set_video_name param1 param2
```

Parameters

param1 String

param1	Description
HDMI	HDMI Input (1)
DP	DisplayPort Input (2)
DVI	DVI Input (3)
VGA	VGA Input (4)
Comp	Composite Video Input (5)

param2 String

Example

```
#set_video_name hdmi Blu-ray  
HDMI INPUT NAME IS SET TO Blu-ray
```

Related Commands

```
#get_video_name
```

#get_video_name

Displays the Web GUI name for the specified video input.

Syntax

```
#get_video_name param1
```

Parameters

param1 Video Input

param1	Description
HDMI	HDMI Input (1)
DP	DisplayPort Input (2)
DVI	DVI Input (3)
VGA	VGA Input (4)
Comp	Composite Video Input (5)

Examples

```
#get_video_name hdmi
HDMI INPUT NAME IS SET TO Video1
```

```
#get_video_name dvi
DVI INPUT NAME IS SET TO !@#%^&*()+
```

```
#get_video_name hdmi
HDMI INPUT NAME IS SET TO Blu-ray
```

Related Commands

```
#set_video_name
```

#set_audio_name

Sets the Web GUI name for the specified audio input. The value of *param2* cannot exceed 12 characters in length and cannot contain spaces.

Syntax

```
#set_audio_name param1 param2
```

Parameters

param1 String

param1	Description
OPT	Optical Input
COAX	Coaxial Input
LR1	Analog Stereo Input 1
LR2	Analog Stereo Input 2

param2 String

Example

```
#set_video_name hdmi Blu-ray Player  
HDMI INPUT NAME IS SET TO Blu-ray
```

Related Commands

```
#get_audio_name
```

#get_audio_name

Displays the Web GUI name for the specified audio input.

Syntax

```
#get_audio_name param1
```

Parameters

param1 String

param1	Description
OPT	Optical Input
COAX	Coaxial Input
LR1	Analog Stereo Input 1
LR2	Analog Stereo Input 2

Example

```
#get_video_name hdmi  
HDMI INPUT NAME IS SET TO Video1
```

Related Commands

```
#set_audio_name
```

#set_contrast

Sets the picture contrast. The default value is 50.

Syntax

```
#set_contrast param1
```

Parameters

<i>param1</i>	Integer	[0 ... 100]
---------------	---------	-------------

Example

```
#set_contrast 50  
PICTURE CONTRAST SET TO 50
```

Related Commands

```
#get_contrast
```

#get_contrast

Displays the picture contrast setting.

Syntax

```
#get_contrast
```

Parameters

None

Example

```
#get_contrast  
PICTURE CONTRAST SET TO 0
```

Related Commands

```
#set_contrast
```

#set_brightness

Sets the picture brightness. The default value is 50.

Syntax

```
#set_brightness param1
```

Parameters

<i>param1</i>	Integer	[0 ... 100]
---------------	---------	-------------

Example

```
#set_brightness 60  
PICTURE BRIGHTNESS SET TO 60
```

Related Commands

```
#get_brightness
```

#get_brightness

Displays the picture brightness setting.

Syntax

```
#get_brightness
```

Parameters

None

Example

```
#get_brightness  
PICTURE BRIGHTNESS SET TO 60
```

Default

```
#set_brightness
```

#set_saturation

Sets the picture saturation. The default setting is 50.

Syntax

```
#set_saturation param1
```

Parameters

<i>param1</i>	Integer	[0 ... 100]
---------------	---------	-------------

Example

```
#set_saturation 48  
PICTURE SATURATION SET TO 48
```

Related Commands

```
#get_saturation
```

#get_saturation

Displays the picture saturation setting.

Syntax

```
#get_saturation
```

Parameters

None

Example

```
#get_saturation  
PICTURE SATURATION SET TO 48
```

Related Commands

```
#set_saturation
```

#set_hue

Sets the picture hue. The default value is 50.

Syntax

```
#set_hue param1
```

Parameters

<i>param1</i>	Integer	[0 ... 100]
---------------	---------	-------------

Example

```
#set_hue 65  
PICTURE HUE SET TO 65
```

Related Commands

```
#get_hue
```

#get_hue

Displays the picture hue setting.

Syntax

```
#get_hue
```

Parameters

None

Example

```
#get_hue  
PICTURE HUE SET TO 65
```

Related Commands

```
#set_hue
```

#set_color_range

Sets the output color range. Set Color Range to Limited if your connected display can only handle a limited RGB range (16 - 235). Otherwise shadows will be “too black” and highlights will be “too white”. If your display can handle a full color range (0 - 255), set Color Range to “Full”. The default value is Full.

Syntax

```
#set_color_range param1
```

Parameters

param1 Integer [0 ... 1]

param1	Description
0	Full
1	Limited

Example

```
#set_color_range 1  
PICTURE COLOR RANGE SET TO LIMITED
```

Related Commands

```
#get_color_range
```

#get_color_range

Displays the output color range setting.

Syntax

```
#get_color_range
```

Parameters

None

Example

```
#get_color_range  
PICTURE COLOR RANGE SET TO LIMITED
```

Related Commands

```
#set_color_range
```

#set_color_temp

Sets the picture color temperature. The default value is Neutral.

Syntax

```
#set_color_temp param1 param2
```

Parameters

param1 Integer [0 ... 3]

param1	Description
0	Warm
1	Neutral
2	Cool
3	User

param2 Integer [0 ... 100]

Example

```
#set_color_temp 0
PICTURE COLOR TEMP SET TO WARM
```

Related Commands

```
#get_color_temp
```

#get_color_temp

Displays the picture color temperature setting.

Syntax

```
#get_color_temp
```

Parameters

None

Example

```
#get_color_temp  
PICTURE COLOR TEMP SET TO WARM
```

Related Commands

```
#set_color_temp
```

#set_color_balance

Sets the picture color balance. This commands can only be used when setting the #set_color_temp command to USER. The default value for all color channels is 50.

Syntax

```
#set_color_balance param1 param2
```

Parameters

param1 Integer [0 ... 2]

param1	Description
0	Red Channel
1	Green Channel
2	Blue Channel

param2 Integer [0 ... 100]

Examples

```
#set_color_balance 0 45
PICTURE COLOR BALANCE RED CHANNEL SET TO 45
```

If Color Temperature is *not* set to USER, then the following feedback will be produced:

```
#set_color_balance 0 45
COLOR TEMP IS NOT USER!!!
```

Related Commands

```
#set_color_temp
#get_color_balance
```

#get_color_balance

Displays the picture color balance setting of the specified color channel.

Syntax

```
#get_color_balance param1
```

Parameters

param1 Integer [0 ... 2]

param1	Description
0	Red Channel
1	Green Channel
2	Blue Channel

Example

```
#get_color_balance 2  
PICTURE COLOR BALANCE BLUE CHANNEL SET TO 50
```

Related Commands

```
#set_color_balance
```

#set_sharpness

Sets the picture sharpness. The default value is 0.

Syntax

```
#set_sharpness param1
```

Parameters

<i>param1</i>	Sharpness	[0 ... 100]
---------------	-----------	-------------

Example

```
#set_sharpness 40  
PICTURE SHARPNESS SET TO 40
```

Related Commands

```
#get_sharpness
```

#get_sharpness

Displays the picture sharpness setting.

Syntax

```
#get_sharpness
```

Parameters

None

Example

```
#get_sharpness  
PICTURE SHARPNESS SET TO 40
```

Related Commands

```
#get_sharpness
```

#set_input_hdcp

Enables or disables HDCP compatibility on the specified input. The default value for both DVI and HDMI is On.

Syntax

```
#set_input_hdcp param1 param2
```

Parameters

param1

String

param1	Description
hdmi	HDMI Input
dvi	DVI Input

param2

Integer

[0 ... 1]

param2	Description
0	Off
1	On

Example

```
#set_input_hdcp hdmi 1
HDMI INPUT HDCP IS SET TO ON
```

Related Commands

```
#get_input_hdcp
```

#get_input_hdcp

Displays the HDCP compatibility of the specified input.

Syntax

```
#set_input_hdcp param1
```

Parameters

param1 String

param1	Description
hdmi	HDMI Input
dvi	DVI Input

Example

```
#get_input_hdcp hdmi  
HDMI_INPUT_HDCP_IS_SET_TO_ON
```

Related Commands

```
#set_input_hdcp
```

#set_uo_scan

Sets the amount of underscan or overscan on the output. The default value for both underscan and overscan is Off.

Syntax

```
#set_uo_scan param1 param2
```

Parameters

param1

Character

param1	Description
U	Underscan
O	Overscan

param2

Integer

[0 ... 3]

param2	Description
0	Off
1	3%
2	6%
3	9%

Example

```
#set_uo_scan O 2
OVERSCAN SET TO 6%
```

Related Commands

```
#get_uo_scan
```

#get_uo_scan

Displays the current underscan / overscan setting.

Syntax

```
#get_uo_scan
```

Parameters

None

Example

```
#get_uo_scan  
OVER/UNDERSCAN SET TO 6%
```

Related Commands

```
#get_uo_scan
```

#send_hpd

Sends an HPD (Hot Plug Detect) event to the specified video input. See also [Setup ▶ HPD Pulse \(page 95\)](#).

Syntax

```
#send_hpd param1
```

Parameters

param1

String

param1	Description
hdmi	HDMI Input
dvi	DVI Input
dp	DisplayPort Input

Example

```
#send_hpd hdmi  
HPD PULSE SENT
```

Related Commands

```
#send_hpd hdmi
```

#set_auto_size

Enables the VGA input auto size adjustment.

Syntax

```
#set_auto_size
```

Parameters

None

Example

```
#set_auto_size  
VGA AUTO SIZE TRIGGERED
```

Example

```
#set_auto_size
```

#set_phase

Sets the phase value for the VGA input. The default value is 0.

Syntax

```
#set_phase param1
```

Parameters

<i>param1</i>	Integer	[0 ... 100]
---------------	---------	-------------

Example

```
#set_phase 50  
VGA PHASE SET TO 50
```

Related Commands

```
#get_phase
```

#get_phase

Displays the phase value for the VGA input.

Syntax

```
#get_phase
```

Parameters

None

Example

```
#get_phase  
VGA PHASE SET TO 0
```

Example

```
#get_phase
```

#set_h_position

Sets the horizontal picture position for the VGA input. The default value is 0.

Syntax

```
#set_h_position param1
```

Parameters

<i>param1</i>	Input	[0 ... 100]
---------------	-------	-------------

Example

```
#set_h_position 0  
VGA HORIZONTAL POSITION SET TO 0
```

Related Commands

```
#get_h_position
```

#get_h_position

Displays the horizontal picture position of the VGA input.

Syntax

```
#get_h_position
```

Parameters

None

Example

```
#get_h_position  
VGA HORIZONTAL POSITION SET TO 0
```

Example

```
#set_h_position
```

#set_v_position

Sets the vertical picture position for the VGA input. The default value is 0.

Syntax

```
#set_v_position param1
```

Parameters

<i>param1</i>	Integer	[0 ... 100]
---------------	---------	-------------

Example

```
#set_v_position 5  
VGA VERTICAL POSITION SET TO 5
```

Related Commands

```
#get_v_position
```

#get_v_position

Displays the vertical picture position of the VGA input.

Syntax

```
#get_v_position
```

Parameters

None

Example

```
#get_v_position  
VGA VERTICAL POSITION SET TO 5
```

Related Commands

```
#set_v_position
```

#set_aspect_ratio

Sets the aspect ratio of the output. The default value is Source.

Syntax

```
#set_aspect_ratio param1
```

Parameters

param1 Integer [0 ... 3]

param1	Description
0	16:9
1	4:3
2	Stretch
3	Source (follows Source aspect)

Example

```
#set_aspect_ratio 2  
ASPECT RATIO SET TO STRETCH
```

Related Commands

```
#get_aspect_ratio
```

#get_aspect_ratio

Displays the aspect ratio setting.

Syntax

```
#get_aspect_ratio
```

Parameters

None

Example

```
#get_aspect_ratio  
ASPECT RATIO SET TO STRETCH
```

Related Commands

```
#set_aspect_ratio
```

#set_mute

Mutes or un-mutes both analog and HDMI outputs. The default value is Unmute.

Syntax

```
#set_mute param1
```

Parameters

param1 Integer [0 ... 1]

param1	Description
0	Unmute
1	Mute

Example

```
#set_mute 1  
AUDIO IS SET TO MUTE
```

Related Commands

```
#get_mute
```

#get_mute

Displays the mute / un-mute status.

Syntax

```
#get_mute
```

Parameters

None

Example

```
#get_mute  
AUDIO IS SET TO MUTE
```

Related Commands

```
#set_mute
```

#set_analog_vol

Sets the volume setting of the analog output. The default value is 100.

Syntax

```
#set_analog_vol param1
```

Parameters

<i>param1</i>	Integer	[0 ... 100]
---------------	---------	-------------

Example

```
#set_analog_vol 50  
ANALOG AUDIO VOLUME SET TO 50
```

Related Commands

```
#get_analog_vol
```

#get_analog_vol

Displays the analog output volume setting.

Syntax

```
#get_analog_vol
```

Parameters

None

Example

```
#get_analog_vol  
ANALOG AUDIO VOLUME SET TO 100
```

Related Commands

```
#set_mute
```

#set_analog_out

Enables or disables the analog output. The default value is On.

Syntax

```
#set_analog_out param1
```

Parameters

param1 Integer [0 ... 1]

param1	Description
0	Off
1	On

Example

```
#set_analog_out 1  
ANALOG AUDIO OUTPUT IS SET TO ON
```

Related Commands

```
#get_analog_out
```

#get_analog_out

Displays the analog output status.

Syntax

```
#get_analog_out
```

Parameters

None

Example

```
#get_analog_out  
ANALOG AUDIO OUTPUT IS SET TO ON
```

Related Commands

```
#set_analog_out
```

#set_analog_mode

Sets the analog output mode to fixed or variable volume. The default value is Fixed.

Syntax

```
#set_analog_mode param1
```

Parameters

param1 Analog Output Volume Mode [0 ... 1]

param1	Description
0	Fixed
1	Variable

Example

```
#set_analog_mode 1  
ANALOG AUDIO OUTPUT IS SET TO VARIABLE
```

Related Commands

```
#get_analog_mode
```

#get_analog_mode

Displays the analog output volume mode

Syntax

```
#get_analog_mode
```

Parameters

None

Example

```
#get_analog_mode  
ANALOG AUDIO OUTPUT IS SET TO VARIABLE
```

Related Commands

```
#set_analog_mode
```

#set_audio_link

Sets the associated audio source for the selected video input. If **VGA** or **Comp** are selected, then **Source** is not an available audio selection.

Default Audio Linking

HDMI	Source (HDMI)
DP	Source (DisplayPort)
DVI	Optical
VGA	LR 1
Comp	LR 2

Syntax

```
#set_audio_link param1 param2
```

Parameters

param1

String

param1	Description
HDMI	HDMI Input (1)
DP	DisplayPort Input (2)
DVI	DVI Input (3)
VGA	VGA Input (4)
COMP	Composite Video Input (5)

(continued on next page)

param2

String

param1	Description
INT*	Embedded audio
OPT	Optical Audio Input
COAX	Coaxial Audio Input
LR1	Analog Stereo Audio Input 1
LR2	Analog Stereo Audio Input 2
NOAUDIO	No Audio
NC	No Change (keep current audio input source)

* Must be HDMI, DVI, or DisplayPort input.

Examples

```
#set_audio_link hdmi opt
HDMI AUDIO LINKED TO OPT
```

```
#set_audio_link hdmi off
HDMI AUDIO LINKED TO OFF
```

Related Commands

```
#get_audio_link
```

#get_audio_link

Displays the current audio link status.

Syntax

```
#get_audio_link param1
```

Parameters

param1

Video Input

param1	Description
HDMI	HDMI Input (1)
DP	DisplayPort Input (2)
DVI	DVI Input (3)
VGA	VGA Input (4)
COMP	Composite Video Input (5)

Example

```
#get_audio_link hdmi  
HDMI AUDIO LINKED TO SOURCE
```

```
#get_audio_link dvi  
DVI AUDIO LINKED TO OPT
```

Related Commands

```
#set_audio_link
```

#set_edid

Sets the type of EDID to be used by the Multi-Format Processor. The argument for *param2* is dependent upon the value of *param1*. The argument for *param4* is dependent upon the value of *param3*.

Syntax

```
#set_edid param1 param2 param3 param4
```

Parameters

param1

Source type

param1	Description
INT	Internal EDID
BANK	EDID Bank
INPUT	HDMI / DP / DVI / VGA Input
OUTPUT	HDMI / DVI Output

param2

Source

param2	Description
0 ... 7	Internal EDID * (<i>param1</i> must be INT)
1 ... 8	EDID Bank (<i>param1</i> must be BANK)
HDMI DP DVI VGA	EDID from Input (<i>param1</i> must be INPUT)
HDMI DVI	EDID from Display (<i>param1</i> must be OUTPUT)

* See next page for Internal EDID descriptions.

(continued on next page)

param3 Destination Type

param3	Description
INPUT	Internal EDID
BANK	EDID Bank

param4 Destination

param4	Description
HDMI DP DVI VGA	EDID to Inputs (<i>param3</i> must be INPUT)
1 ... 8	EDID Banks 1 - 8 (<i>param3</i> must be BANK)

Example

```
#set_edid int 3 input hdmi
INTERNAL EDID 3 IS SAVED TO INPUT HDMI
```

```
#set_edid bank 1 bank 3
BANK EDID 1 IS SAVED TO BANK 3
```

Notes

Internal EDID descriptions for *param2*

1	DVI 1080p	5	DisplayPort 2CH 1080p
2	HDMI 2CH 720p	5	DisplayPort Multichannel 1080p
3	HDMI 2CH 1080p	6	VGA 1080p
4	HDMI Multichannel 1080p		

Default EDID Settings

HDMI	Internal	2-Channel	1080p
DisplayPort	Internal	2-channel	1080p
DVI	Internal	N/A	1080p
VGA	Internal	N/A	1080p

#set_bank_name

Sets the name for the specified EDID bank.

Syntax

```
#set_bank_name param1 param2
```

Parameters

<i>param1</i>	Integer	[1 ... 8]
<i>param2</i>	String	

Example

```
#set_bank_name 1 Gefen_EDID  
EDID BANK 1 NAME IS SET TO Gefen_EDID
```

```
#set_bank_name 2 Fitzzy's_EDID  
EDID BANK 2 NAME IS SET TO Fitzzy's_EDID
```

```
#set_bank_name 3 Projector  
EDID BANK 3 NAME IS SET TO Projector
```

Related Commands

```
#get_bank_name
```

#get_bank_name

Displays the name for the specified EDID bank.

Syntax

```
#get_bank_name param1
```

Parameters

<i>param1</i>	Integer	[1 ... 8]
---------------	---------	-----------

Example

```
#get_bank_name 1  
EDID BANK 1 NAME IS Bank_1
```

```
#get_bank_name 8  
EDID BANK 8 NAME IS Bank_8
```

Related Commands

```
#set_bank_name
```

#get_ipconfig

Displays the current IP settings.

Syntax

```
#get_ipconfig
```

Parameters

None

Example

```
#get_ipconfig
IP CONFIGURATION IS:
(DHCP)
    IP : 10.5.64.223
NETMASK : 255.255.255.0
GATEWAY : 10.5.64.1
MAC ADDRESS = 00:1c:91:04:50:13
```

Related Commands

```
#get_ipconfig
```

#set_ipmode

Sets the IP mode to DHCP or Static. The default value is DHCP.

Syntax

```
#set_ipmode param1
```

Parameters

param1 IP Setting Mode [0 ... 1]

param1	Description
0	DHCP
1	Static

Example

```
#set_ipmode 1
IP MODE SET TO STATIC
A REBOOT IS REQUIRED TO APPLY CHANGES
```

Related Commands

```
#get_ipmode
```

#get_ipmode

Displays the current IP mode.

Syntax

```
#get_ipmode
```

Parameters

None

Examples

```
#get_ipmode  
IP MODE SET TO DHCP
```

```
#get_ipmode  
IP MODE SET TO STATIC
```

Related Commands

```
#set_ipmode
```

#set_ipadd

Sets the IP address of the Multi-Format Processor. The IP address must be entered using dot-decimal notation. The Multi-Format Processor must be rebooted after executing this command. The default IP address is 192.168.1.72.

Syntax

```
#set_ipadd param1
```

Parameters

param1 IP address

Example

```
#set_ipadd 10.5.64.26
```

Related Commands

```
#get_ipadd
```

#get_ipadd

Displays the IP address of the Multi-Format Processor.

Syntax

```
#get_ipadd
```

Parameters

None

Example

```
#get_ip  
IP ADDRESS IS : 10.5.64.26
```

Related Commands

```
#set_ipadd
```

#set_netmask

Sets the subnet mask. The subnet mask must be entered using dot-decimal notation. The Multi-Format Processor must be rebooted after executing this command. The default net mask is 255.255.255.0.

Syntax

```
#set_netmask param1
```

Parameters

<i>param1</i>	Subnet mask
---------------	-------------

Example

```
#set_netmask 255.255.0.0
NETMASK ADDRESS IS : 255.255.0.0
PLEASE REBOOT THE UNIT TO APPLY CHANGES
```

Related Commands

```
#get_netmask
```

#get_netmask

Displays the subnet mask of the Multi-Format Processor.

Syntax

```
#get_netmask
```

Parameters

None

Example

```
#get_netmask  
NETMASK ADDRESS IS : 255.255.0.0
```

Related Commands

```
#set_netmask
```

#set_gateway

Sets the gateway address. The gateway must be typed using dot-decimal notation. The Multi-Format Processor must be rebooted after executing this command. The default gateway is 192.168.1.254.

Syntax

```
#set_gateway param1
```

Parameters

<i>param1</i>	Gateway address
---------------	-----------------

Example

```
#set_gateway 192.168.25.254  
GATEWAY ADDRESS IS : 192.168.25.254  
PLEASE REBOOT THE UNIT TO APPLY CHANGES
```

Related Commands

```
#get_gateway
```

#get_gateway

Displays the gateway address of the Multi-Format Processor. The gateway address is generally the IP Address of the system router.

Syntax

```
#get_gateway
```

Parameters

None

Example

```
#get_gateway  
GATEWAY ADDRESS IS : 192.168.1.254
```

Related Commands

```
#set_gateway
```

#set_http_port

Specifies the Web server listening port. The Multi-Format Processor must be rebooted after executing this command. The default port setting is 80.

Syntax

```
#set_http_port param1
```

Parameters

<i>param1</i>	Integer	[1 ... 1024]
---------------	---------	--------------

Example

```
#set_http_port 81
HTTP COMMUNICATION PORT 81 IS SET
PLEASE REBOOT THE UNIT TO APPLY CHANGES
```

Related Commands

```
#get_http_port
```

#get_http_port

Displays the current HTTP listening port.

Syntax

```
#get_ip
```

Parameters

None

Example

```
#get_http_port  
HTTP COMMUNICATION PORT IS 80
```

Related Commands

```
#set_http_port
```

#set_telnet_enable

Enables or disables Telnet access. The default setting is Enabled.

Syntax

```
#set_telnet_enable param1
```

Parameters

param1 Integer [0 ... 1]

param1	Description
0	Disabled
1	Enabled

Example

```
#set_telnet_enable 1  
TELNET ACCESS IS ENABLED
```

Related Commands

```
#get_telnet_enable
```

#get_telnet_enable

Displays the current Telnet access status.

Syntax

```
#get_telnet_enable
```

Parameters

None

Example

```
#get_telnet_enable  
TELNET ACCESS IS ENABLED
```

Related Commands

```
#set_telnet_enable
```

#set_telnet_port

Sets the Telnet listening port. The default port is 23.

Syntax

```
#set_telnet_port param1
```

Parameters

<i>param1</i>	Integer	[0 ... 1024]
---------------	---------	--------------

Example

```
#set_telnet_port 23
TELNET COMMUNICATION PORT 23 IS SET
PLEASE REBOOT THE UNIT.
```

Related Commands

```
#get_telnet_port
```

#get_telnet_port

Displays the Telnet listening port.

Syntax

```
#get_telnet_port
```

Parameters

None

Example

```
#get_telnet_port  
TELNET COMMUNICATION PORT IS 23
```

Related Commands

```
#set_telnet_port
```

#set_use_telnet_pass

Enables or disables the Telnet password. The default value is Disabled.

Syntax

```
#set_use_telnet_pass param1
```

Parameters

param1 Integer [0 - 1]

param1	Description
0	Password Disabled
1	Password Enabled

Example

```
#set_use_telnet_pass 0  
TELNET INTERFACE PASSWORD IS DISABLED
```

Related Commands

```
#get_use_telnet_pass
```

#get_use_telnet_pass

Displays the status of the Telnet password.

Syntax

```
#get_use_telnet_pass
```

Parameters

None

Example

```
#get_use_telnet_pass  
TELNET INTERFACE PASSWORD IS DISABLED
```

Related Commands

```
#set_use_telnet_pass
```

#set_telnet_welcome

Enables or disables the Telnet Welcome Screen. When enabled, the following message will be displayed at the beginning of each Telnet session: Welcome to EXT-MFP TELNET. This message is enabled, by default. The message may be disabled for communications with some control systems.

Syntax

```
#set_telnet_welcome param1
```

Parameters

param1 Telnet Welcome [0 ... 1]

param1	Description
0	Telnet Welcome Disabled
1	Telnet Welcome Enabled

Example

```
#set_telnet_welcome 0
TELNET WELCOME SCREEN IS DISABLED
```

Related Commands

```
#get_telnet_welcome
```

#get_telnet_welcome

Displays the status of Telnet Welcome Screen.

Syntax

```
#get_telnet_welcome
```

Parameters

None

Example

```
#get_telnet_welcome  
TELNET WELCOME SCREEN IS DISABLED
```

Related Commands

```
#set_telnet_welcome
```

#set_udp_port

Sets the UDP listening port. The default port is 50007.

Syntax

```
#set_udp_port param1
```

Parameters

<i>param1</i>	Integer	[1 ... 65535]
---------------	---------	---------------

Example

```
#set_udp_port 50007
UDP COMMUNICATION PORT 50007 IS SET
PLEASE REBOOT THE UNIT
```

Related Commands

```
#get_udp_port
```

#get_udp_port

Displays the UDP listening port.

Syntax

```
#get_udp_port
```

Parameters

None

Example

```
#get_udp_port  
UDP SERVER PORT IS 50007
```

Related Commands

```
#set_udp_port
```

#set_remote_udp_enable

Enables or disables remote UDP access.

Syntax

```
#set_remote_udp_enable param1
```

Parameters

param1 Integer [0 ... 1]

param1	Description
0	Remote UDP Access Disabled
1	Remote UDP Access Enabled

Example

```
#set_remote_udp_enable 1  
REMOTE UDP IS ENABLED
```

Related Commands

```
#get_remote_udp_enable
```

#get_remote_udp_enable

Displays the remote UDP access status.

Syntax

```
#get_remote_udp_enable
```

Parameters

None

Example

```
#get_remote_udp_enable  
REMOTE UDP ACCESS IS ENABLED
```

Related Commands

```
#set_remote_udp_enable
```

#set_udp_remote_ip

Sets the remote UDP IP address. The IP address must be specified using dot-decimal notation. The default UDP remote IP address is 192.168.1.255. The Multi-Format Processor must be rebooted after executing this command.

Syntax

```
#set_udp_remote_ip param1
```

Parameters

param1 IP address

Example

```
#set_udp_remote_ip 192.168.1.129  
UDP_REMOTE_IP_ADDRESS : 192.168.1.129
```

Related Commands

```
#get_udp_remote_ip
```

#get_udp_remote_ip

Displays the remote UDP IP address.

Syntax

```
#get_udp_remote_ip
```

Parameters

None

Example

```
#get_udp_remote_ip  
UDP REMOTE IP ADDRESS : 192.168.1.129
```

Related Commands

```
#set_udp_remote_ip
```

#set_udp_remote_port

Sets the remote UDP listening port. The default port is 50008.

Syntax

```
#set_udp_remote_port param1
```

Parameters

<i>param1</i>	Integer	[1 ... 65535]
---------------	---------	---------------

Example

```
#set_udp_remote_port 50008  
UDP REMOTE PORT IS 50008
```

Related Commands

```
#get_udp_remote_port
```

#get_udp_remote_port

Displays the remote UDP listening port.

Syntax

```
#get_udp_remote_port
```

Parameters

None

Example

```
#get_udp_remote_port  
UDP REMOTE PORT IS 50008
```

Related Commands

```
#set_remote_udp_port
```

#set_udp_enable

Enables or disables UDP access. The default setting is Enabled.

Syntax

```
#set_udp_enable param1
```

Parameters

param1 Integer [0 ... 1]

param1	Description
0	UDP Access Disabled
1	UDP Access Enabled

Example

```
#set_udp_enable 1  
UDP ACCESS IS ENABLED
```

Related Commands

```
#get_udp_enable
```

#get_udp_enable

Displays the UDP access status.

Syntax

```
#get_udp_enable
```

Parameters

None

Example

```
#get_udp_enable  
UDP ACCESS IS ENABLED
```

Related Commands

```
#set_udp_enable
```

#set_webui_ad_pass

Sets the Administrator password for the Web GUI. The password is case-sensitive and cannot exceed 7 characters in length. The default password is `Admin`.

Syntax

```
#set_webui_ad_pass param1
```

Parameters

<i>param1</i>	String
---------------	--------

Example

```
#set_webui_ad_pass b055man  
WEB UI ADMINISTRATOR PASSWORD IS SET b055man
```

Related Commands

```
#set_webui_op_pass
```

#set_webui_op_pass

Sets the Operator password for the Web GUI. The password is case-sensitive and cannot exceed 7 characters in length. The default password is: Operator.

Syntax

```
#set_webui_op_pass param1
```

Parameters

<i>param1</i>	Password
---------------	----------

Example

```
#set_webui_op_pass m1ni0n  
WEB UI OPERATOR PASSWORD IS SET m1ni0n
```

Related Commands

```
#set_webui_ad_pass
```

#set_discovery

Enables or disables the Discovery Service (Gefen Syner-G Discovery Tool). The default value is Enabled.

Syntax

```
#set_discovery param1
```

Parameters

param1 State [0 ... 1]

param1	Description
0	Discovery Disabled
1	Discovery Enabled

Example

```
#set_discovery 1  
DISCOVERY SERVICE IS ENABLED
```

Related Commands

```
#get_discovery
```

#get_discovery

Displays the Discovery Service status.

Syntax

```
#get_discovery
```

Parameters

None

Example

```
#get_discovery  
DISCOVERY SERVICE IS ENABLED
```

Related Commands

```
#set_discovery
```

#set_showme

Enables or disables the “Show Me” feature. When the “Show Me” feature is enabled, all the audio and video Input lights on the front panel will flash. This quickly identifies a unit and is useful when multiple units are being used. The default setting is Off.

Syntax

```
#set_showme param1
```

Parameters

param1 Integer [0 ... 1]

param1	Description
0	Turn “Show Me” Off
1	Turn “Show Me” On

Examples

```
#set_showme 1
SHOWME IS ON
```

```
#set_showme 0
SHOWME IS OFF
```

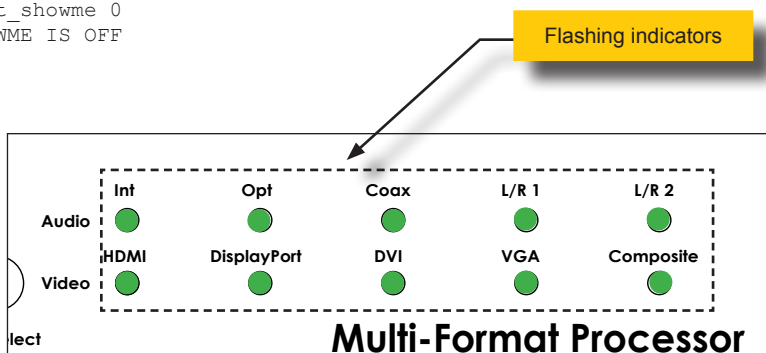

Related Commands

```
#get_discovery
```

#set_discovery_mode

Sets the read / write mode of the Discovery Service. The default value is Read / Write.

Syntax

```
#set_discovery_mode param1
```

Parameters

param1 State [0 ... 1]

param1	Description
0	Read / Write
1	Read Only

Examples

```
#set_discovery_mode 1
DISCOVERY MODE READ ONLY
```

```
#set_discovery_mode 0
DISCOVERY MODE READ/WRITE
```

Related Commands

```
#set_discovery
#get_discovery
```

#get_discovery_mode

Displays the read/write mode of the Discovery Service.

Syntax

```
#get_discovery_mode
```

Parameters

None

Example

```
#get_discovery_mode  
DISCOVERY MODE 0
```

Related Commands

```
#set_discovery_mode
```

#set_device_descr

Assigns a name to the Multi-Format Processor. This is useful when there are multiple devices in a project and you want to give them different names (e.g. Conf Rm 1, Conf Rm 2, etc.) The value of *param1* cannot exceed 12 characters in length. The Device Description will show on the Gefen Syner-G Discovery page. The default name is EXT-MFP.

Syntax

```
#set_device_descr param1
```

Parameters

<i>param1</i>	String
---------------	--------

Example

```
#set_device_desc Conf Rm 1  
DEVICE DESCRIPTION NAME IS SET TO Conf Rm 1
```

Related Commands

```
#get_device_descr
```

#get_device_desc

Displays the device description.

Syntax

```
#get_device_desc
```

Parameters

None

Example

```
#get_device_desc  
DEVICE DESCRIPTION NAME IS SET TO Conf Rm 1
```

Related Commands

```
#set_device_desc
```

#set_osd_timeout

Sets the timeout value (in seconds) for the On-Screen Display. The default timeout value is 5 seconds.

Syntax

```
#set_osd_timeout param1
```

Parameters

param1 Integer [0, 5 ... 60]

param1	Description
0	Off
5 ... 60	Seconds until Timeout

Example

```
#set_osd_timeout 0  
OSD TIMEOUT IS SET TO OFF
```

```
#set_osd_timeout 60  
OSD TIMEOUT IS SET TO 60
```

Related Commands

```
#get_osd_timeout
```

#get_osd_timeout

Displays the timeout value for the On-Screen Display.

Syntax

```
#get_osd_timeout
```

Parameters

None

Example

```
#get_osd_timeout  
OSD TIMEOUT IS SET TO 5
```

Related Commands

```
#set_osd_timeout
```

#set_display_notify

Sets the on-dscreen timeout (in seconds) of the display characteristics. When the video source changes, this window can pop up to show the new resolution. The default timeout value is 5 seconds.

Syntax

```
#set_display_notify param1
```

Parameters

param1 Integer [0 ... 2]

param1	Description
0	5 Seconds
1	Off
2	Always On

Example

```
#set_display_notify 1  
DISPLAY NOTIFICATIONS SET TO OFF
```

Related Commands

```
#get_display_notify
```

#get_display_notify

Displays the current timeout value for the on-screen display characteristics.

Syntax

```
#get_display_notify
```

Parameters

None

Example

```
#get_display_notify  
DISPLAY NOTIFICATIONS SET TO OFF
```

Related Commands

```
#set_display_notify
```

#set_feedback

Enable or disable unsolicited command feedback for RS-232, TCP, and UDP protocols. The default value is On.

Syntax

```
#set_feedback param1
```

Parameters

param1 Integer [0 ... 1]

param1	Description
0	Off
1	On

Example

```
#set_feedback 1
FEEDBACK IS ON
```

Notes

- Feedback shall be sent whenever a status is changed, whether it is changed by RS-232, Web GUI, IR, Contact closure, or Front Panel buttons.
- Feedback shall be the same as #get_feedback Command.
- Feedback can be turned off via the #set_feedback Command.

#get_feedback

Displays the status of the command feedback.

Syntax

```
#get_feedback
```

Parameters

None

Example

```
#get_feedback  
FEEDBACK IS ON
```

Related Commands

```
#set_feedback
```

#get_firmware_version

Displays the current version of firmware.

Syntax

```
#get_firmware_version
```

Parameters

None

Example

```
#get_firmware_version  
FIRMWARE VERSION IS 1.2
```

Related Commands

#set_ir_channel

Sets the IR channel for the Multi-Format Processor. The default IR channel setting is 1. The IR channel for the Multi-Format Processor can also be set under the [System \(page 108\)](#) tab within the Web interface.

Syntax

```
#set_ir_channel param1
```

Parameters

param1 IR Channel [1 ... 4]

param1	Description
1	Channel 1
2	Channel 2
3	Channel 3
4	Channel 4

Example

```
#set_ir_channel 3  
IR CHANNEL IS SET TO 3
```

Related Commands

```
#get_ir_channel
```

#get_ir_channel

Displays the current IR channel of the Multi-Format Processor.

Syntax

```
#get_ir_channel
```

Parameters

None

Example

```
#get_ir_channel  
IR CHANNEL IS SET TO 1
```

Related Commands

```
#set_ir_channel
```

#factory_reset

Reset the Multi-Format Processor to factory-default settings. The Multi-Format Processor *must* be power-cycled after executing this command.



Important

This command also resets the IP address to "Static" 192.168.1.72. If the IP address has changed, this will disconnect the Multi-Format Processor from the network. Use the Gefen Syner-G Discovery Tool to locate the Multi-Format Processor and assign the new network settings to work on your network.

Syntax

```
#factory_reset
```

Parameters

None

Example

```
#factory_reset
UNIT IS SET TO FACTORY DEFAULTS
INPUT SET TO HDMI
ASPECT RATIO SET TO SOURCE
PICTURE CONTRAST SET TO 50
PICTURE BRIGHTNESS SET TO 50
PICTURE HUE SET TO 50
PICTURE SHARPNESS SET TO 0
HDMI INPUT HDCP IS SET TO ON
OUTPUT COLOR SPACE OF OUTPUT 2 SET TO RGB 444
OUTPUT MODE OF OUTPUT 1 SET TO AUTO
OUTPUT MODE OF OUTPUT 2 SET TO AUTO
BACKGROUND COLOR SET TO BLUE
PICTURE COLOR RANGE SET TO LIMITED
OVER/UNDERSCAN SET TO OFF
AUDIO INPUT SET TO SOURCE
COMP AUDIO LINKED TO LR2
UNIT IS SET TO FACTORY DEFAULTS
IP MODE SET TO STATIC
A REBOOT IS REQUIRED TO APPLY CHANGES
```

#reboot

Reboots the Multi-Format Processor.

Syntax

```
#reboot
```

Parameters

None

Example

```
#reboot  
DEVICE HAS BEEN REBOOTED
```

Multi-Format Processor

4

Appendix

Menu	Option	Sub-option	Setting
Output Setup	Resolution	---	1080p60
	Colorspace	Output 1	RGB 4:4:4
		Output 2	RGB 4:4:4
	Mode	Output 1	Auto Detect
		Output 2	Auto Detect
Background Color	---	Blue	
Picture			
Picture	Contrast	---	50
	Brightness	---	50
	Saturation	---	50
	Hue	---	50
	Range	---	Limited
	Color Temp (VGA only)	---	Neutral
	Balance (VGA only)	Red	50
		Green	50
Blue		50	
Sharpness	---	0	
Adjust			
Adjust	Auto Size (VGA only)	---	---
	Phase (VGA only)	---	50
	V Position (VGA only)	---	0
	H Position (VGA only)	---	50
	Under/Over Scan	---	Off
	Aspect Ratio	---	Source
	HDCP	---	On
	Send HPD Pulse	---	---
Audio			
Audio	Analog Out	---	On
	Analog Mode	---	Fixed
	HDMI Link	---	Internal
	DisplayPort (DP) Link	---	Internal
	DVI Link	---	Optical
	VGA Link	---	L/R 1
	Composite (Comp) Link	---	L/R 2

Menu	Option	Sub-option	Setting	
Network	IP Mode	---	Static	
	IP Address	---	192.168.1.72	
	Subnet Mask	---	255.255.255.0	
	Default (Def) Gateway	---	192.168.1.1	
	HTTP Port	---	80	
	Telnet	---	Enable	
	Telnet Port	---	23	
	UDP	---	Disable	
	UDP Port	---	50007	
	Remote UDP	Access	---	Disable
		IP Address	---	192.168.1..255
	Port	---	50008	
Discovery	---	---	On	
System	OSD	---	5 Sec	
	Display Notify	---	5 Sec	
	Low Power	---	IP Off	
	Set Feedback	---	On	
	Input Res. Info	---	---	
	Firmware Version	---	---	
	IR Channel	---	1	
	Factory Reset	---	---	

Rack Tray Installation

The following illustrations provide instructions for installing the Multi-Format Processor in the *Gefen 1U Rack Tray* (Gefen part no. EXT-RACK-1U).

Step 1 Turn unit upside down.

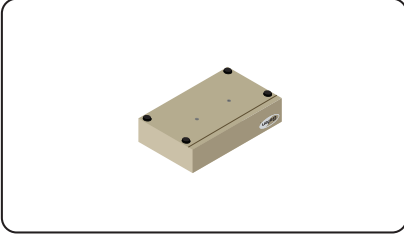

Step 2 Remove rubber feet.

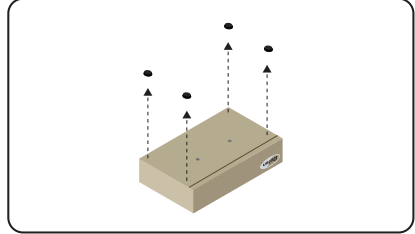

Step 3 Line up holes on unit and rack tray.

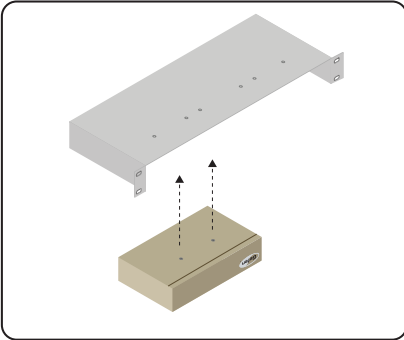

Step 4 Install countersink screws.

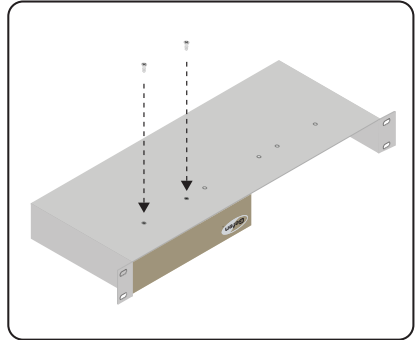

Step 5 Ensure the unit is installed securely.

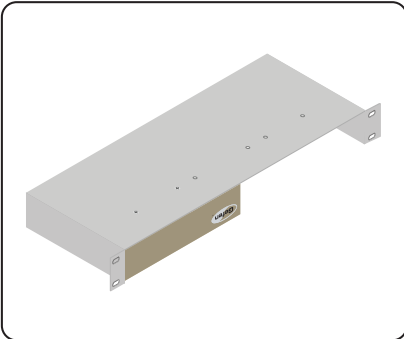

Step 6 Unit has been installed into rack tray.

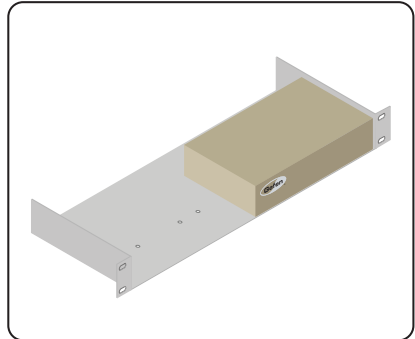

Connectors, Controls, and Indicators	
Video Input	<ul style="list-style-type: none"> • 1 x VGA 15-pin, female • 1 x DisplayPort, 20-pin, female • 1 x DVI-I, 29-pin, female (digital only) • 1 x VGA HD-15, female • 1 x Composite, RCA-type, female
Video Output	<ul style="list-style-type: none"> • 1 x HDMI Type-A 19-pin, female • 1 x DVI-I, 29-pin, female (digital only)
Audio Input	<ul style="list-style-type: none"> • 2 x 3.5mm mini-stereo • 1 x TOSLINK®, female • 1 x S/PDIF, RCA-type, female
Audio Output	<ul style="list-style-type: none"> • 2 x RCA-type
USB	<ul style="list-style-type: none"> • 1 x Mini-B (factory use only)
IR Sensor	<ul style="list-style-type: none"> • 1 x located on front panel
IR Extender	<ul style="list-style-type: none"> • 1 x 3.5mm mini-stereo
Contact Closure	<ul style="list-style-type: none"> • 1 x 6-pin Phoenix
IP	<ul style="list-style-type: none"> • 1 x RJ-45
RS-232	<ul style="list-style-type: none"> • 1 x DB-9, female
Input Select Button	<ul style="list-style-type: none"> • 1 x tact-type
Power / Standby Button	<ul style="list-style-type: none"> • 1 x tact-type
Power / Standby Indicator	<ul style="list-style-type: none"> • 1 x LED, multicolor, blue / red
Video Input Indicators	<ul style="list-style-type: none"> • 5 x LED, green
Audio Input Indicators	<ul style="list-style-type: none"> • 5 x LED, green
Power Connector	<ul style="list-style-type: none"> • 1 x 3-pin Kycon KPJX-35 type, locking

(continued on next page)

Operational	
Maximum Pixel Clock	• 165 MHz
Maximum TMDS Clock	• 225 MHz
Power Supply	• 12V DC
Power Consumption	• 8.5W maximum
Operating Temperature	• +32 to +122 °F (0 to +50 °C)
Operating Temperature	• 5% to 90% RH, non-condensing
Storage Temperature	• -4 to +185 °F (-20 to +85 °C)
Storage Humidity	• 0% to 95% RH, non-condensing
MTBF	• 50000 hours

Physical	
Dimensions (W x H x D)	• 8.4" x 1.6" x 8.5" (213mm x 41mm x 216mm)
Unit Weight	• 3.2 lbs (1.5 kg)

A

Aspect Ratio 53

Audio

analog *audio mode* 63 *disabling output* 61 *enabling output* 61 *input* *selecting* 15 *linking* 65

Audio Output

analog audio *mode* 63

Auto Size 39

B

Brightness 23

C

Color Balance 34

Color Range 29

Color Temperature 31

Commands

#factory_reset 234 *#get_analog_mode* 179 *#get_analog_out* 177 *#get_analog_vol* 175 *#get_aspect_ratio* 171 *#get_audio_input* 128 *#get_audio_link* 182 *#get_audio_name* 141 *#get_background_color* 136 *#get_bank_name* 186 *#get_brightness* 145 *#get_color_balance* 155 *#get_color_range* 151 *#get_color_temp* 153 *#get_contrast* 143 *#get_device_desc* 224 *#get_discovery* 219 *#get_discovery_mode* 222 *#get_display_notify* 228 *#get_feedback* 230 *#get_firmware_version* 231 *#get_gateway* 195 *#get_h_position* 167 *#get_http_port* 197 *#get_hue* 149 *#get_input* 126 *#get_input_hdcp* 159 *#get_input_res* 137 *#get_ipadd* 191 *#get_ipconfig* 187 *#get_ipmode* 189 *#get_ir_channel* 233 *#get_mac_addr* 123 *#get_mute* 173 *#get_netmask* 193 *#get_osd_timeout* 226 *#get_output_color* 132 *#get_output_mode* 134 *#get_output_res* 130 *#get_phase* 165 *#get_power* 121 *#get_remote_udp_enable* 209 *#get_saturation* 147 *#get_sharpness* 157 *#get_telnet_enable* 199 *#get_telnet_port* 201 *#get_telnet_welcome* 205 *#get_udp_enable* 215 *#get_udp_port* 207 *#get_udp_remote_ip* 211 *#get_udp_remote_port* 213 *#get_uo_scan* 161 *#get_use_telnet_pass* 203 *#get_video_name* 139 *#get_v_position* 169 *#help* 124 *#power* 120 *#reboot* 235 *#send_hpd* 162 *#set_analog_mode* 178 *#set_analog_out* 176 *#set_analog_vol* 174 *#set_aspect_ratio* 170 *#set_audio_input* 127 *#set_audio_link* 180 *#set_audio_name* 140 *#set_auto_size* 163 *#set_background_color* 135 *#set_bank_name* 185 *#set_brightness* 144 *#set_color_balance* 154 *#set_color_range* 150 *#set_color_temp* 152

#set_contrast 142
 #set_device_descr 223
 #set_discovery 218
 #set_discovery_mode 221
 #set_display_notify 227
 #set_edid 183
 #set_feedback 229
 #set_gateway 194
 #set_h_position 166
 #set_http_port 196
 #set_hue 148
 #set_input 125
 #set_input_hdcp 158
 #set_ipadd 190
 #set_ipmode 188
 #set_ir_channel 232
 #set_low_power 122
 #set_mute 172
 #set_netmask 192
 #set_osd_timeout 225
 #set_output_color 131
 #set_output_mode 133
 #set_output_res 129
 #set_phase 164
 #set_remote_udp_enable 208
 #set_saturation 146
 #set_sharpness 156
 #set_showme 220
 #set_telnet_enable 198
 #set_telnet_port 200
 #set_telnet_welcome 204
 #set_udp_enable 214
 #set_udp_port 206
 #set_udp_remote_ip 210
 #set_udp_remote_port 212
 #set_uo_scan 160
 #set_use_telnet_pass 202
 #set_video_name 138
 #set_v_position 168
 #set_webui_ad_pass 216
 #set_webui_op_pass 217

Configuration

IP 115

Contrast 21

Control

contact closure 75

IP 76

RS-232 76

Control Methods 75

D

Default Settings 238

Disabling

analog audio output 61

Discovery

App 77

Syner-G Software Suite 77

Display Notify 72

E

EDID

Manage EDID tab

EDID Copy 98

EDID Info 99

EDID Mode 97

Edit Bank Names 100

Mange EDID

Upload / Download EDID 101

Enabling

analog audio output 61

F

Factory Reset 74

Features vi

Feedback

command 73

Firmware Version

displaying 73

G

Gateway. *See* IP Settings

H

HDCP 56

HDMI

HDCP 56

HPD 59

Horizontal Position 47

HPD 59

HTTP Port. *See* IP Settings

Hue 27

I

- Input Resolution
 - displaying* 20
- Installation 9
 - wiring diagram* 10
- IP Configuration 115
- IP Settings 68
- IR Channel
 - multi-format processor* 74
- IR Remote Control
 - installing the batteries* 7
 - setting the IR channel* 8
 - using* 16

L

- Lower Power 73

M

- Main tab 81
- Menu System
 - accessing* 17
 - horizontal position* 47
 - OSD timeout* 72
 - vertical position* 44

N

- Network tab
 - Discovery Protocol Settings* 106
 - IP Settings* 102
 - TCP/Telnet Settings* 103
 - UDP Settings* 104
 - Web Login Settings* 105

O

- Operating Notes v
- OSD Timeout 72
- Output Resolution
 - displaying* 20
 - setting* 18
- Overscan 50

P

- Packing List *vii*
- Phase 41
- Picture
 - aspect ratio* 53
 - auto size* 39
 - brightness* 23
 - color balance* 34
 - color range* 29
 - color temperature* 31
 - contrast* 21
 - horizontal position* 47
 - hue* 27
 - overscan* 50
 - phase* 41
 - saturation* 25
 - sharpness* 37
 - underscan* 50
 - vertical position* 44
- Position
 - horizontal* 47
 - vertical* 44
- Powering off 14
- Powering on 14
- Power Setting
 - Low 73

R

- Rack Tray Installation 240
- Reset
 - factory-default settings* 74
- RS-232
 - interface* 114
 - settings* 114

S

- Safety instructions *ii*
- Saturation 25
- Selecting an Audio Input 15
- Selecting a Video Input 15
- Setup tab
 - audio* 90
 - HDCP* 96
 - HPD pulse* 95
 - input* 88
 - names* 94

- output* 84
 - picture* 86
- Sharpness 37
- Specifications 241
- Status tab 83
- Subnet Mask. *See* IP Settings
- Syner-G
 - Discovery App* 77
 - Discovery Tool* 77
 - using* 78
- System Settings 71
- System tab 108

T

- Table of Contents *viii*
- Technical support *iv*
- Telnet Port. *See* IP Settings
- Telnet Settings. *See* IP Settings
- Timeout
 - Display Notify* 72
 - OSD* 72

U

- UDP Port. *See* IP Settings
- UDP Settings. *See* IP Settings
- Underscan 50

V

- Vertical Position 44
- VGA
 - Auto Size* 39
 - color temperature* 31
 - horizontal position* 47
 - phase* 41
 - vertical position* 44
- Video Input
 - selecting* 15

W

- Warranty information *iii*
- Web Interface 80
- Wiring Diagram 10



20600 Nordhoff St., Chatsworth CA 91311
1-800-545-6900 818-772-9100 fax: 818-772-9120
www.gefen.com support@gefen.com